



Air Handling Unit RT 250/400S-EC-RS

INSTALLATION

DESIGN & TECHNICAL INFORMATION

OPERATION & CONTROL PANEL

MAINTENANCE & SERVICE

**Exhaust air filter, article No: Q120101
Supply air filter, article No: Q120100**

June 2013

**Easy to
maintain**

**Efficient heat
recovery**

Low noise level

**Low energy
consumption**



	Page
Installation	
Safety	3
Receipt of goods	3
Installation - how	3
Installation - where	3
Condensate drain	3
Connecting ducts	3
Outdoor air, extract air	3
Mounting the duct system	3
Silencers	3
Temperature sensors - location	4
Insulation	4
Duct cover for AHU top	4
Air diffusers	4
Transmitted air, between rooms	4
Stove/fireplace	4
Kitchen flue	4
Power connection	4
DUC - how to remove	5
Connecting the AHU, wiring diagram	6
Terminal blocks	6-7

Design & technical information

Product description	8
Casing	8
Filter, exhaust air	8
By-pass damper	8
Fan, exhaust air	8
Fan, supply air	8
Heat exchanger	8
Filter, supply air	8
Access door	8
Adjustable feet	8
Condensate drain	8
Control panel	8
After-heater	8
Functional diagram - supply air control	9
Chiller / Cooling coil (optional)	9
Technical specification	10
Measurements	10

Operation & control unit

Contents (Operation & control unit)	11-12
Control unit menu screens	13- 40

	Page
Maintenance & service	
Cleaning	42
Changing filters	42
Cleaning fans	42
Cleaning the heat exchanger	42
Checking the condensate drain	42
Cleaning, air diffusers	43
Cleaning the duct system	43
Checking the outdoor air intakes	43
Service	43
Disposal	43
List of abbreviations	43

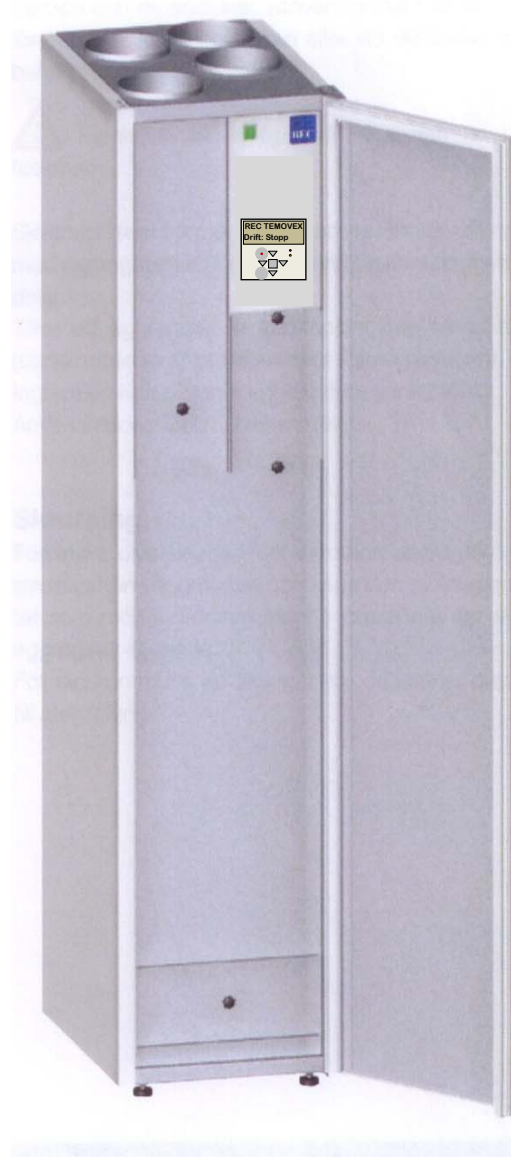

Safety



Read this user's guide carefully before installing the Air Handling Unit (abbreviated AHU), particularly those parts marked with the above safety sign.

If you use and care for your AHU in a correct way, it will perform in the best possible way for a long time.

The AHU creates an indoor climate that is very good, at the same time as energy is saved due to efficient heat recovery.

NOTE! This user's guide should be stored together with the AHU, and should be passed on to possible new owners.

Receipt of goods

Check the following before you sign the delivery note:

- the number of cartons should conform to the delivery note/packing list
- there should be no visible transport damages.

The AHU should be stored indoors.



If possible, store the AHU laying down before installation, in order to avoid it tipping over. This is particularly important if there are children around.

Installation - how

Work carried out by laymen may impair the performance of the AHU and cause injury or damage to persons or property. If the unit is installed incorrectly, it will not be possible to achieve the desirable benefits, such as satisfactory air quality and maximum energy savings.

The AHU is heavy. Edges and corners, which you would not normally come into contact with, may be sharp. Therefore, we suggest you wear gloves when moving the unit.



Keep an eye on children! Before the unit has been installed, it may easily tip over if abnormally loaded.

Installation - where

The unit can be installed in for example a scullery, laundry or similar. Recommended minimum temperature in the room is +12°C. At lower temperature, heat loss and more condensate water could be a problem.

Place the unit upright on a flat and solid foundation. In order to avoid structure-borne sounds, there should be a gap of at least 10 mm between unit and wall. We also recommend that walls to adjacent rooms are soundproofed. These precautions should be taken although the Temovex AHU is considered

very silent. The unit has adjustable rubber feet and well balanced fans, to avoid vibration.

The unit should be installed in such a way that it is easy to access for maintenance and inspection.

Make sure the front door can be fully opened.

The AHU should be placed in such a way that water cannot splash over it. As an option, the unit can be equipped with protection that enables the installation to comply with IP class X5.

Condensate drain

The Temovex unit is fitted with a condensate drain at the bottom of the unit, 3/4". This should be connected to a drain or fed to a floor drain. Make sure the drain pipe is lowered well down in the floor drain, or there might be a cold draft. There is no need for a water seal.

NOTE! The condensate drain has to be connected when the unit is installed.

If the unit is fitted with the optional condensation boiler (KAVK), no external connection is required.

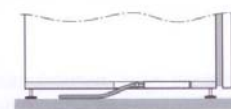

Connecting ducts

Ducts and duct details should be made from an age-resistant material, and should be easy to clean inside. A flexible duct connector can be used where a short connection between for example roof hood and duct system is needed.

Tumble dryers and drying cabinets must not be connected directly to the duct system.

Outdoor air, extract air

The outdoor air intake, fitted with an external wall grille, is best positioned on the north or east wall of the building, slightly above ground level in order to avoid dirt from the ground. The outdoor air intake should be placed at a distance from kitchen flues, exhausts from central vacuum cleaners, etc.

Extract air should be discharged above roof level via a roof hood.

Mounting the duct system

Ducts and duct details are fitted in accordance with the instructions given by the duct supplier, normally using 3 pop rivets or special assembly screws at each joint. If duct details with rubber seals are used, no additional joint sealing is required.

Silencers

Silencers dimensioned for the installation should be fitted both for the supply air and exhaust air, either directly onto the Temovex unit, or to the duct system as close to the unit as possible. Under certain conditions, silencers on the outdoor air duct as well as extract air duct may be necessary.

Temperature sensors - location

Sensors for outdoor air, exhaust air and extract air are already mounted in the AHU's respective air ducts. They are also electrically connected to the control system.

Should the unit be equipped with an after-heater, the sensor for freeze protection is mounted and connected.

The sensor for supply air is just electrically connected upon delivery. It should be placed in the supply air duct, at least 0,6 m from the heater to avoid direct heat radiation, and after the first bend if possible, where the temperature is more homogeneous.

NOTE! Seal the lead-through carefully.

If a room sensor is used, it should be placed approx. 1,8 m above floor level in the living room, preferably on an inner wall.

Insulation

Outdoor air and extract air ducts in heated spaces must be insulated against condensation along their entire length, using an insulation sleeve with minimum 30 mm insulation. The diffusion barriers are sealed using ventilation tape.

Supply air and exhaust air ducts in warm rooms do not need to be insulated against condensation, however, heat insulation may be appropriate. This should be decided in each individual case.

Supply air and exhaust air ducts located in cold or unheated rooms should be insulated against frost. If blanket insulation is used, 2 layers with overlapping joints should be achieved, with a minimum insulating thickness of 120 mm.

If loose-fill insulation is being laid, the layer covering the ducts must be at least 150 mm.

Duct cover for AHU top

The lacquered, 2-piece cover hides the ducts at the top of the Temovex unit. The cover is telescopic and will fit ceiling heights between 2,30 - 2,70 m. We recommend a gap of 5 mm between ceiling and duct cover to avoid any transfer of vibrations.

1. Measure the distance from the top of the unit (without duct cover) to the ceiling. Assemble the two pieces on a flat surface/floor, and ensure that the height will allow a gap of approx. 5 mm to the ceiling. Use the enclosed 4 self-tapping screws to make the holes in the upper (smaller) cover plate. Use the 4 white screws to join the two cover plates.

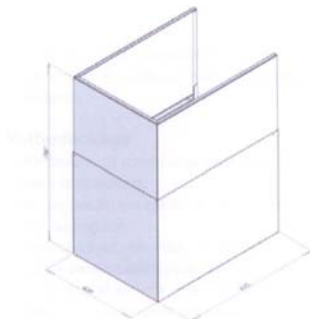

2. Put the duct cover on top of the unit, placing the

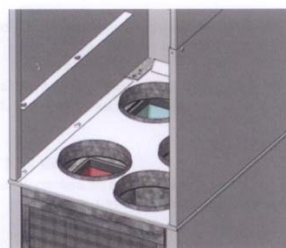

screw-heads in the "key" holes. Fix the cover onto the unit by sliding it backwards some 5 mm (see picture). If the duct cover is mounted onto an existing unit, the

pop rivets at the unit top have to be replaced by screws.

3. Whenever you need access to the upper part of the Temovex unit, the duct cover is lifted off in one piece (point 2 above, but reverse order)



Air diffusers

Supply air diffusers are normally installed in rooms where people spend much time, such as bedrooms and living room.

Exhaust air diffusers are normally installed in "damp and smelly" rooms, for example bathroom, laundry etc.

Both supply and exhaust air valves can be mounted on the wall or in the ceiling. They should be placed where they can easily be demounted for cleaning, service or inspection of the duct system.

Transmitted air between rooms

To facilitate the circulation of air in the home, supply air from rooms with such valves must be given the chance to move to rooms with exhaust air valves. Use doors with an air transfer slit, or doors without door sill (minimum 70 cm² free area/exhaust air valve).

Alternatively, wall mounted transfer air grilles can be used.

Stove/fireplace

Most modern stoves have a separate outdoor air connection which provides combustion air to the stove. If this is not available/possible, a separate outdoor air device should be mounted. The stove consumes some 150-300 m³/h.

To facilitate the lighting of fires (to start with, the stove door should be left ajar) an option is to provide the Temovex AHU with a "stove" button.

Kitchen flue

The cooker fan is fitted with a separate fireproof spiral duct. The extract air is fed out via a roof hood. Use an approved duct and 2 speed clamps to connect the cooker hood/kitchen fan to the kitchen flue.

Power connection

The AHU is provided with a grounded plug. Connect the plug to an earthed 1-phase socket (230 VAC / 10 A). Connection at the top of the unit.

Removing the DUC



DUC

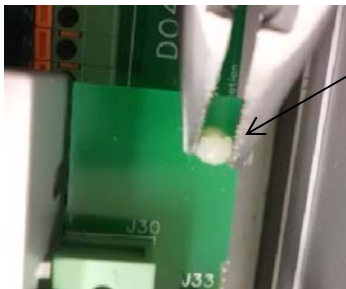

Remove the DUC from the circuit card by squeezing each top of the four spacers with a pair of pliers. Squeeze one at a time and ease the DUC out at the same time.



The DUC is now attached to the card by 2 flat cables only.



The spring locks on the plugs of the DUC's flat cables make it easy to loosen them from the circuit card.

The bottom card can now be reached and set up with required functions.

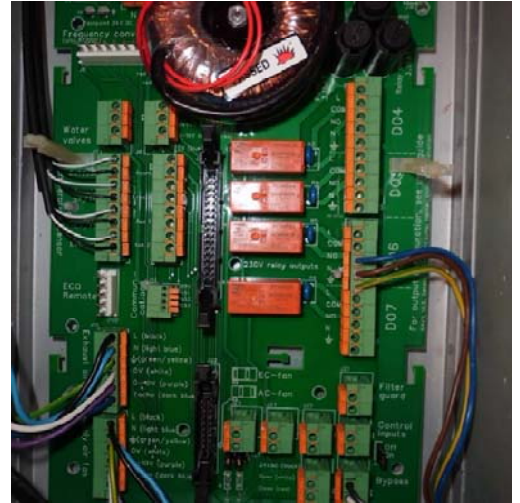

After the installation of functions is done, re-fit the DUC in reverse order.

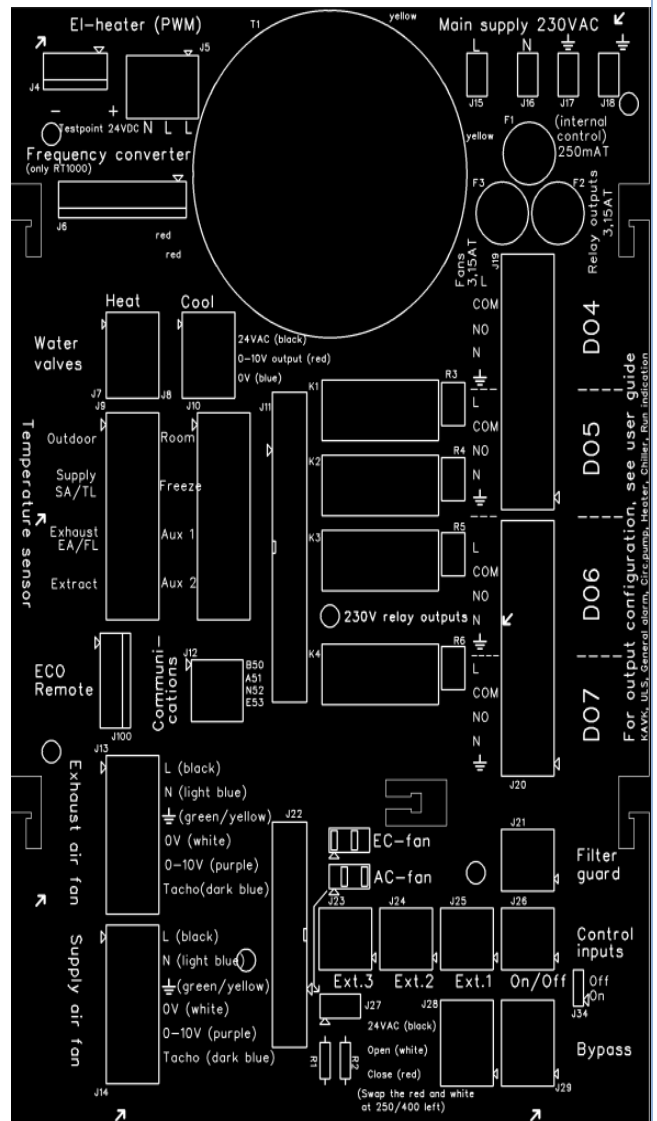

The printed circuit card's text guide.

Description of terminal blocks

General

Joining of circuits is made on the bottom circuit card. To access the circuit card, remove the DUC (see previous page).

Texts on the circuit card show where to connect what. All terminals have a Jxx No. on pin 1, and a small triangle.

When in the following text for example J26/1,2 is stated, it means that the function should be connected to terminal J26, pin 1 and 2.

Where appropriate, the signal is marked on the card.

External cooling (terminal J8/1,2,3)

The AHU can be fitted with an external water chiller (cooling coil), for example natural cooling from a drilling hole. The chiller is controlled via an external control valve (0-10 V).

After-heating water (terminal J7/1,2,3)

The water heater is controlled via an external control valve (0-10 V).

(The cable may already be connected upon delivery)

Temperature sensors (terminal J9)

Temperature sensors (PT1000) for outdoor air, supply air, exhaust air and extract air are already connected upon delivery.

Room sensor (terminal J10/1,2)

If a room sensor is installed, this must be stated in the AHU's configuration. This is done by a

qualified installer.

Freeze protection - After-heater (terminal J10/3,4)

In connection with water heating, a freeze protection (temperature) sensor is fastened on the return wire of the after-heater, in order to protect the after-heater from freezing,

Modbus (J12)

Terminal for possible modbus communication.

ECO Remote (J100)

Terminal for connecting a remote control (optional) with among other things change-over switch for ECO mode and alarm indication.

NOTE! When using ECO Remote, DO6 must be configured for Normal flow, DO7 for Sum alarms and D12 for ECO.

Fans (J13 and J14)

Terminals for the fans. These are already connected upon delivery.

By-pass (J28)

Connection terminal for the by-pass damper.

Optional terminal for by-pass (J29)

Extra connection terminal for by-pass damper (some AHU models)

Ext.1, Ext.2 and Ext.3 (terminals J23 to J25/1,2)

As an optional extra, you can choose to connect three external switches that will change the speed of the fans in accordance with the preset values. Suitable air flows have been preset, but may be altered by a qualified installer, using the control panel.

To see which options are available, please turn to chapter "Operation & control unit".

Start/stop (terminal J26/1,2)

An external switch for "Start/stop" can be connected. The switch makes the AHU stop running, but does not make it powerless. If this function is used, the jumper J34 should be moved to mode OFF.

Optional terminal for filter guard (J21)

For some of the larger AHU models only.

Relay outputs (terminals J19, J20)

The system has 4 identical relay outputs which can be configured to various functions. The configuration shown above is one example, and others may be made.

To see which options are available, please turn to chapter "Operation & control unit".

A condensation boiler (KAVK), if any, would be installed at the factory.

Mains voltage (terminals J15, J16, J17)

230VAC, 50Hz

Casing (terminal J18)

Ground connection of the casing.

Electric heating, voltage feed (terminal J5/2,3)

Pin 2 phase, pin 3 zero (blue).

Electric heating, control signals (terminal J4)

Frequency converter (terminal J6)

For some of the larger AHU models only.

Product description

RT 250/400S-EC-RS is an air handling unit (AHU) fitted in a cabinet. The unit is designed for the ventilation of homes, offices, nurseries and other small premises.

The Temovex unit should be installed in a heated room, such as a scullery, laundry or similar.

The standard Temovex unit consists of a counterflow heat exchanger, 2 fans, 2 filters, after-heater, by-pass damper and a control system.

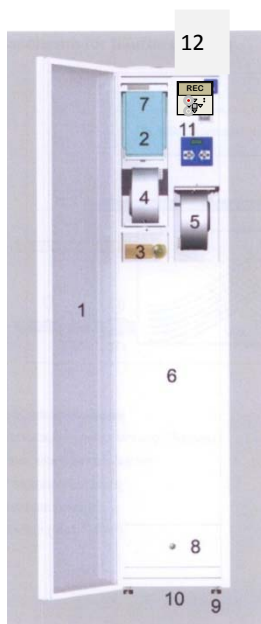

1. Door
2. Filter, exhaust air
3. By-pass damper
4. Fan, exhaust air
5. Fan, supply air
6. Counterflow heat exchanger
7. Filter, supply air (behind 2.)
8. Inspection door
9. Adjustable feet
10. Condensate drain
11. Control panel
12. After-heater

*Above: Unit with left-hand door.
(Nos. 2, 3, 4, 5 and 7 above, are behind cover plates)*

1. Casing

The casing is made of hot galvanised sheet metal with 30 mm insulation between the sheets. As a standard, the side panels and the front are white (powder paint). The front door has a magnetic strip which keeps the door closed. The unit top has sleeve connections where all ducts are connected.

2. Exhaust air filter

G3, bag (art. No. Q120101)

3. By-pass damper

The Temovex AHU has an automatic by-pass damper which makes the air by-pass the heat exchanger whenever heat recovery is not necessary. The by-pass setting is adjusted on the control panel.

4. Exhaust air fan

The low-energy fan is of EC type. It has a wide working range and works at constant flow ("cruise control"), which compensates for filter clogging. The fan motor comes with integrated overheating protection which cuts the power and stops the fan. Reset: turn the fan motor off for approx. 1 min.

5. Supply air fan

The same type as exhaust air fan (see point 4)

6. Heat exchanger

The highly efficient Temovex counterflow heat exchanger was first designed over 30 years ago by our own people, and has since been developed to fit today's needs.

It is made of thin aluminium sheets, and the supply air and exhaust air sides are completely sealed from each other. This is important in order to avoid odours and other contaminants from old air seeping through to fresh air. The heat exchanger has no moving parts, which eliminates wear.

7. Supply air filter

F7, bag (art. No. Q120100).

8. Inspection door

When cleaning the heat exchanger or controlling the condensate drain, the Inspection door is opened. (See chapter "Maintenance & service").

9. Adjustable feet

The cabinet has adjustable rubber feet.

10. Condensate drain

The Temovex unit is fitted with a condensate drain at the bottom of the unit, 3/4". This should be connected to a drain or fed to a floor drain.

11. Control panel

All settings for fan speed, after-heating, by-pass etc. are made via the control panel and the AHU's integrated control system.

If you have added optional parts to your Temovex AHU, these functions, too, are set via the control panel.

12. After-heater

RT 250/400S-EC-RS is fitted with an electric after-heater, 0.9 kW.

As an optional extra, a reinforced electric after-heater, 1.8 kW, or a water coil (two different sizes) for waterborne heating is offered. The heater is integrated in the unit and settings are made via the control panel.

In the case of a water coil, the water connections are at the top of the unit, dimension DN12.

The RT 250/400S-EC-RS with water coil includes a two-way valve and valve motor in the consignment from REC..

Functional diagram - supply air control

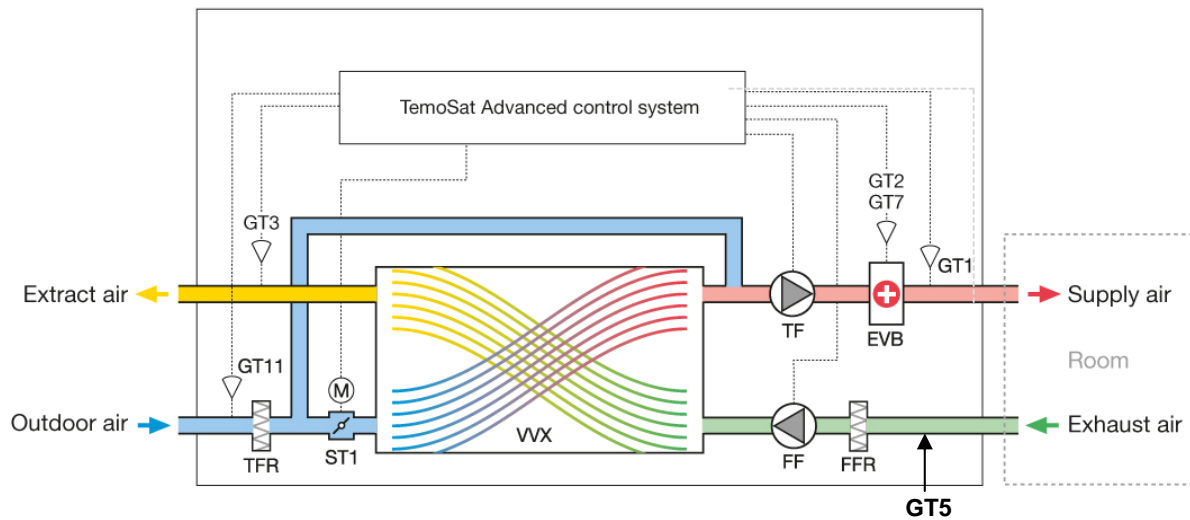

VWX	Counterflow heat exchanger	FF	Fan, exhaust air
ST1	Damper motor, heat recovery (By-pass)	FFR	Filter, exhaust air
TFR	Filter, outdoor air	GT5	Sensor, exhaust air temperature
GT11	Sensor, outdoor air temperature	TF	Fan, supply air
GT3	Sensor, extract air temperature	EVB	After-heater, electricity/water
		GT1	Sensor, supply air temperature
		GT2	Overheating protection (when electric coil)
		GT7	Freeze protection (when water coil)

Chiller (cooling coil) EKB (optional)

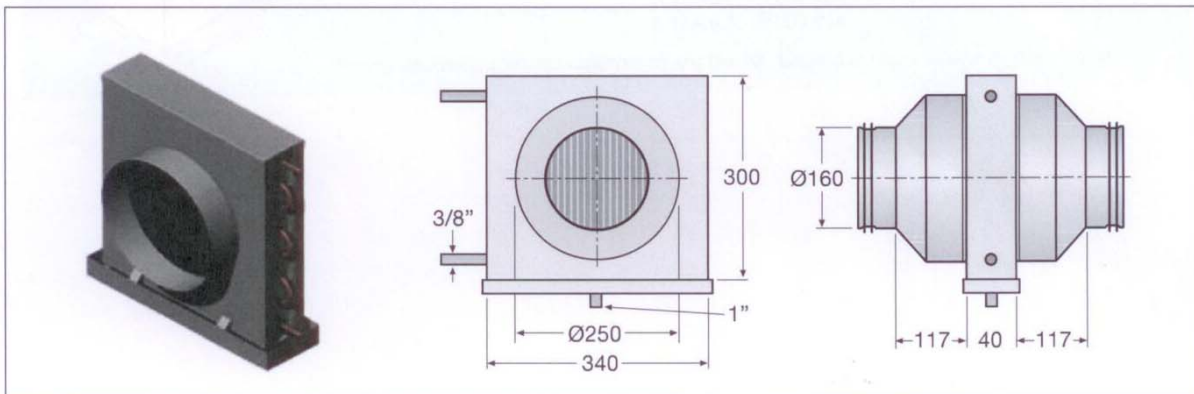

Technical specification

	Electrical version		HW version Water temp. 55/45°C	
	RT250	RT400	RT250	RT400
Rated output, unit	1034 W	1138 W	134 W	238 W
Rated output, standard heater	900 W		1150 W	1500 W
Rated output, reinforced heater	1800 W		2000 W	2800 W
Rated output, fans	2 x 67 W	2 x 119 W	2 x 67 W	2 x 119 W
Voltage/Frequency input	230 V, 50 Hz		230 V, 50 Hz	
Fuse	10 A		10 A	
Filter, supply air / exhaust air	Bag F7 / Bag G3		Bag F7 / Bag G3	
Weight	100 kg		100 kg	
Water connection	-		DN12	
Fire classification	A15		A15	
Measurements (WxDxH)	430x620x1900 mm		430x620x1900 mm	
Duct connections	4 x Ø160 mm		4 x Ø160 mm	
Condensate drain	3/4"		3/4"	

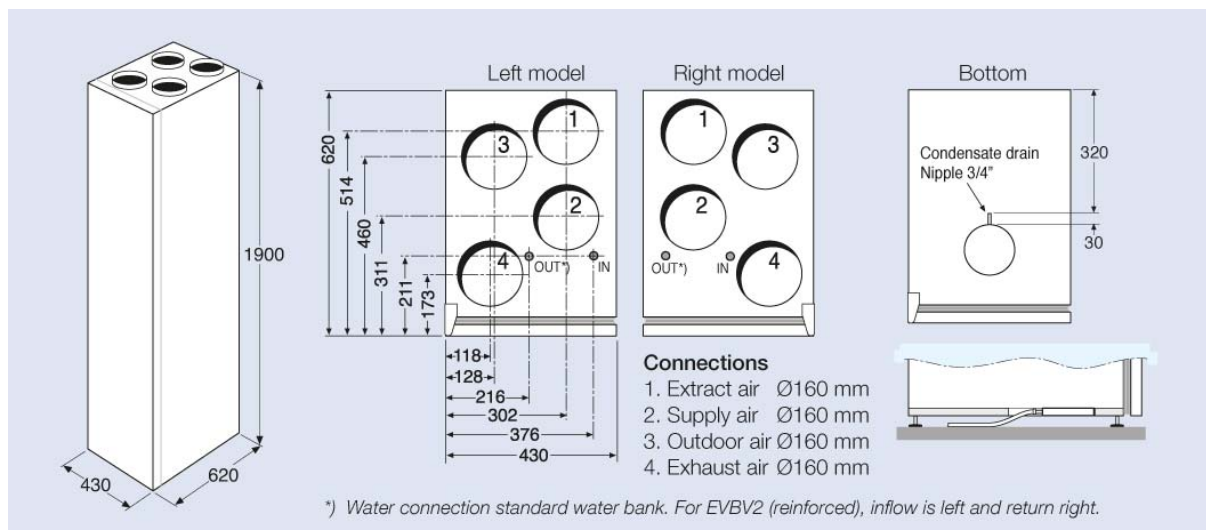
Measurements

Control unit display

Contents	Page
A. Overview	13
Control unit main screen	13
Menu screens	14
How to navigate between menus	
How to change values and settings	
B. Menu screens, structure and contents	15
0 Main menu	15
0.0 Temovex firmware, language, AHU's communication addresses The menu's main groups	16
1 Temperature, setting and reading	17
1.a1 Supply air control	
1.b1 Outdoor temperature compensated supply air control	18
1.c1 Cascaded room temperature control	20
1.d1 Cascaded exhaust air control	21
2 Fan speed, how to change operation mode	22
2.1.1 Fan control	
2.2.1 Date and time	
3 Status of inputs/outputs. Calibration of sensors	26
4 Manual control	28
4.1 Supply air control	
4.2 Supply air fan	
4.3 Exhaust air fan	
4.4 After-heater	
4.5 By-pass damper	29
4.6 Chiller (Cooling coil)	
4.7 Outdoor air damper (ULS)	
4.8 Condensation boiler (KAVK)	
4.9 Circulation pump (CP) after-heater	30
4.10 Circulation pump (CP) chiller	
4.11 Fire damper	
4.12 Filter timer	
5 Alarms	31

6	Configuration	32
6.1	Control function	
6.2	Control of temperature	33
6.3	PID output	
6.4	Fan speed	34
6.5	After-heater	35
6.6	By-pass	36
6.7	Recovery of cold air	
6.8	Night cooling	
6.9	Condensation boiler (KAVK)	37
	<i>(6.10 Fire function - not applicable to RT250/400 units)</i>	
6.11	I/O configuration	
6.12	Modbus	38
6.13	System	
7	Authorization	40

A. Overview

On the following pages you will find information about the basic functions that you yourself can adjust to fit your requirements and wishes. The unit control system optimizes its function according to the settings you define.





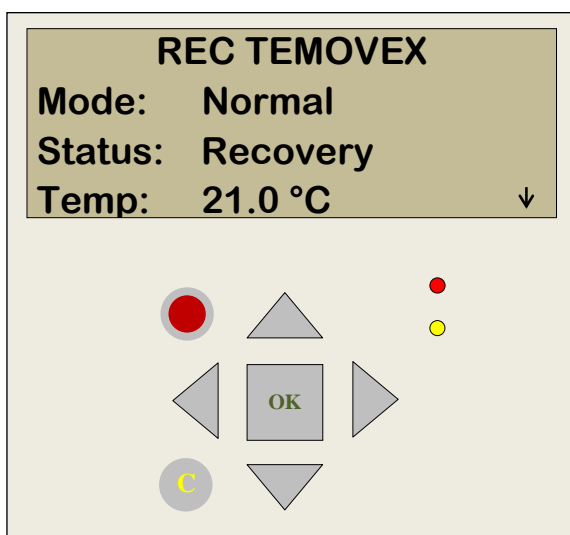

Please note the following:

In the menus regarding heating and cooling, where you have the option of making changes, *Auto Mode* gives you an optimized function. If you select a manual setting, *On or Off*, the manual setting overrules auto settings.

NOTE! There are advanced settings that should be handled by trained professionals only. We recommend that you do not experiment with those.

Control unit main screen



-  UP
-  DOWN
-  RIGHT
-  LEFT
-  CONFIRM
-  ALARM
-  CORRECT/UNDO

● Alarm	Flashing	There are one or several alarms that have not been acknowledged.
	Not flashing	There are one or several alarms that have been acknowledged, but not dealt with.
● Setting	Flashing	User may adjust the settings in this menu.
	Not flashing	Settings cannot be adjusted by the user.

Menu screens

The AHU's settings and status can be studied by scrolling the menu screens. No changes or adjustments can be made without the authorized access code.

If no buttons are pressed for five minutes, the system will automatically revert to the control unit's Main screen.

When the access code has been used to log in, the system will automatically log out when five minutes have passed.

How to navigate between menus

An arrow in the upper or lower corner indicates that there are further menus to be seen if the UP or DOWN arrow is used.

To highlight any of the menus, move the arrow to the left of the text using the UP or DOWN arrows.

Some menus have more headings than can be seen at first. These automatically turn up if you scroll using the arrows. To access the chosen menu, press RIGHT.

In some cases there is an arrow to the right of the text, pointing to the right. This means that there are further menus behind this heading if you press RIGHT.

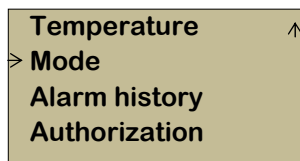

Menu screen, example

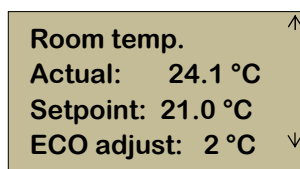

Menu screen, example

How to change values and settings

The yellow LED is flashing in menus where adjustments can be made by the user (see page 12). Press OK.

The variable which may be adjusted flashes.

Use the arrows UP or DOWN to adjust.

Press OK to finalize.

The cursor automatically indicates next variable that is possible to adjust in this menu.

B. Menu screens, structure and contents

The headings below (starting with a numeral) form menus.
 Each numeral refers to a column and a line in the menu.
 The first numeral = column 1 in the menu.
 The 2nd numeral = column 2 etc.
 The value of the numeral tells you the line of the column.
 The Main menu = 0

Example: To reach 2.2.1.1 Summertime

Start-up screen: 1st column, line 0.

To reach: 1st column, 2nd line: press DOWN twice
 2nd column, 2nd line: press RIGHT once, DOWN once (you enter 2nd col. on 1st line)
 3rd column, 1st line: press RIGHT once
 4th column, 1st line: press RIGHT once

Depending on chosen settings, some menus will not appear. In those cases where a letter is shown before the numeral, the letter refers to a certain menu, for example 1.b1.1. In this example, the menu will appear if alternative b has been chosen in another menu.

0 Main menu

Start-up screen

REC TEMOVEX	Line 1 shows name of producer.
Mode: Normal	Line 2 shows mode
Status: Recovering	Line 3 shows status
Temp: 21.0 °C	Line 4 shows setpoint temperature.

0.0. Temovex firmware version

Version	Line 1 shows name of menu (= Version).
Version: 1.0-1-00	Line 2 shows firmware version.
Id number: 12345678	Line 3 shows serial number of the hardware. (Id number)
12:01:31 11:57	Line 4 shows current date and time. How to adjust; see chapter A.

0.0.0. Language

Choose language (see chapter A). Options:

- Swedish
- English

Choose language	Line 1 shows name of menu.
English	Line 2 shows language chosen.

0.0.0.0. The AHU's communication address

Address	Line 1 shows Name of menu.
PLA: 254	Line 2 shows one of the AHUs communication addresses
ELA: 30	Line 3 shows the second communication address

The menu's main groups

There are four main groups: *Temperature, Mode, Alarm history, Authorization.*

There are further menus behind every group where you can monitor current settings and values.

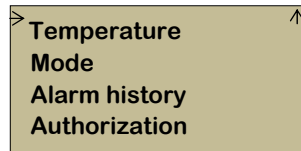

Line 1 Temperature settings - read and adjust*
 Line 2 Operation mode - read and adjust*
 Line 3 Alarm history
 Line 4 Log in/out with access code

After logging in, another 3 Main groups appear (and the order of lines changes):

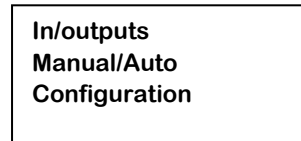

Configuration of inputs/outputs
 Choose automatic or manual operation.
 System configuration.

*NOTE! No adjustments to the settings can be made without logging in with the authorized access code. If and when the code is stated, another 3 Main headings will be visible (see above).

1. Temperature, setting and reading

The information shown under Temperature depends on which control function has been chosen. There are four different control functions to choose from:

- a/ Supply air control
- b/ Outdoor temperature compensated supply air control
- c/ Cascaded room temperature control
- d/ Cascaded exhaust air control

See further information in chapter 6, Configuration. Find the section that corresponds to your configuration, which tells you about how to set and read Temperature.

a/ Supply air control

1.a1. Supply air control

The temperature is controlled by a sensor in the supply air duct. Setpoint temperature can be altered - see Ch. A. Logging in is necessary - see Ch. 7.

ECO, too, can be adjusted.

Supply air temp. Actual: 27.6 °C Setpoint: 21.0 °C ECO adjust: -2 °C	Line 1 shows which temperature is measured. Line 2 shows current temperature. Line 3 shows desired value set. Line 4 shows how much the temperature should be lowered when you are not at home. How to set these temperatures, see 2.2.
---	--

1.a2. Outdoor air temperature.

Outdoor air temp Actual: 2.6 °C	Line 1 shows which temperature is measured. Line 2 shows the temp. of the outdoor air when it reaches the unit. Line 3 Line 4
--	--

1.a3. Exhaust air temperature.

Exhaust air temp. Actual: 21.5 °C	Line 1 shows which temperature is measured. Line 2 shows current temperature. Line 3 Line 4
--	--

1.a4. Temperature of extract air as it leaves the building

Extract air temp. Actual: 10.3 °C	Line 1 shows which temperature is measured. Line 2 shows current temperature. Line 3 Line 4
--	--

1.a5. Freeze protection temperature.

Only shown when there is water heating.

Freeze P temp. Actual: 7.0 °C	Line 1 shows which temperature is measured. Line 2 shows current temperature of the heating circuit's return pipe. Line 3 Line 4
--	---

b/ Outdoor temperature compensated supply air control

1.b1. Outdoor temperature compensated supply air control

The supply air temperature is controlled by a sensor in the supply air duct. Desired setpoint temperature is interpolated from the values set in the menu screens for desired outdoor temperature compensated values at various outdoor temperatures (menu screen 1.b1.1 - 1.b1.3)

OD temp: 2.6 °C	↑	Line 1	shows the outdoor air temperature when it reaches the unit.
Supply air temp.		Line 2	shows which temperature is measured on line 3.
Act.: 27.6 °C	→	Line 3	shows actual temp. + arrow to menu behind for setpoint temp.
Setp.		Line 4	shows interpolated desired value at present outdoor temp.
Comp. SP: 28.0 °C	↓		

1.b1.1 Outdoor temp. compensated supply air control, desired value, part 1

The setting of desired values for the supply air at different outdoor temperatures.

Outdoor comp. setp.	↑	Line 1	shows menu.
-20.0°C = 37.0°C		Line 2	shows set desired value at -20°C.
-15.0°C = 35.0°C		Line 3	shows set desired value at -15°C.
-10.0°C = 33.0°C	↓	Line 4	shows set desired value at -10°C.

1.b1.2 Outdoor temp. compensated supply air control, desired value, part 2

The setting of desired values for the supply air at different outdoor temperatures.

Outdoor comp. setp.	↑	Line 1	shows menu.
5.0°C = 31.0°C		Line 2	shows set desired value at -5°C.
0.0°C = 29.0°C		Line 3	shows set desired value at ±0°C.
5.0°C = 27.0°C	↓	Line 4	shows set desired value at +5°C.

1.b1.3 Outdoor temp. compensated supply air control, desired value, part 3

The setting of desired values for the supply air at different outdoor temperatures.

Outdoor comp. setp.	↑	Line 1	shows menu.
10.0°C = 25.0°C		Line 2	shows set desired value at +10°C.
15.0°C = 23.0°C		Line 3	shows set desired value at +15°C.
ECO adjust: 0 °C	↓	Line 4	shows how much the temperature should be lowered when you are not at home. How to set these temperatures, see 2.2.

1.b2. Supply air temperature.

Supply air temp.	↑	Line 1	shows which temperature is measured.
Actual: 25.4 °C		Line 2	shows current temperature.
		Line 3	
	↓	Line 4	

1.b3. Exhaust air temperature.

Exhaust air temp.	↑	Line 1	shows which temperature is measured.
Actual: 21.5 °C		Line 2	shows current temperature.
		Line 3	
	↓	Line 4	

1.b4. Extract air temperature.

Extract air temp. Actual: 10.3 °C	↑	Line 1	shows which temperature is measured.
		Line 2	shows current temperature.
		Line 3	
	↓	Line 4	

1.b5. Freeze protection temperature.

Only shown when there is water heating.

Freeze P temp. Actual: 7.0 °C	↑	Line 1	shows which temperature is measured.
		Line 2	shows current temperature of the heating circuit's return pipe.
		Line 3	
	↓	Line 4	

c/ Room control

1.c1. Cascaded room temperature control

The temperature is controlled by one sensor in the room and one in the supply air duct. The desired value can be altered - see Ch. A. Logging in is necessary - see Ch. 7. ECO, too, can be adjusted.

Room temp.	↑	Line 1	shows which temperature is measured.
Actual: 21.6 °C		Line 2	shows current temperature.
Setpoint: 22.0 °C	→	Line 3	shows desired value set. To adjust, see below.
ECO adjust: -2 °C	↓	Line 4	shows how much the temperature should be lowered when you are not at home. How to set, see 2.2.

1.c2. Outdoor air temperature.

Outdoor air temp.	↑	Line 1	shows which temperature is measured.
Actual: 2.6 °C		Line 2	shows the temp. of the outdoor air when it reaches the unit.
		Line 3	
	↓	Line 4	

1.c3. Supply air temperature.

Supply air temp.	↑	Line 1	shows which temperature is measured.
Actual: 25.4 °C		Line 2	shows current temperature.
		Line 3	
	↓	Line 4	

1.c4. Exhaust air temperature.

Exhaust air temp.	↑	Line 1	shows which temperature is measured.
Actual: 21.5 °C		Line 2	shows current temperature.
		Line 3	
	↓	Line 4	

1.c5. Temperature of extract air as it leaves the building

Extract air temp.	↑	Line 1	shows which temperature is measured.
Actual: 10.3 °C		Line 2	shows current temperature.
		Line 3	
	↓	Line 4	

1.c6. Freeze protection temperature.

Only shown when there is water heating.

Freeze P temp.	↑	Line 1	shows which temperature is measured.
Actual: 0.0 °C		Line 2	shows current temperature of the heating circuit's return pipe.
		Line 3	
		Line 4	

d/ Exhaust air control

1.d1. Cascaded exhaust air control

One temperature sensor in the room and one in the supply air channel help achieve a constant, settable room temperature.

The desired value (setpoint) can be altered - see Ch. A. Logging in is necessary - see Ch. 7. ECO can be adjusted.

Exhaust air temp.	↕	Line 1	shows which temperature is measured.
Actual: 21.6 °C		Line 2	shows current temperature.
Setpoint: 22.0 °C	>	Line 3	shows desired value set.
ECO adjust: -2 °C	↕	Line 4	shows how much the temperature should be lowered when you are not at home. How to set, see 2.2.

1.d2. Outdoor air temperature.

Outdoor air temp.	↕	Line 1	shows which temperature is measured.
Actual: 2.6 °C		Line 2	shows the temp. of the outdoor air when it reaches the unit.
		Line 3	
	↕	Line 4	

1.d3. Supply air temperature.

Supply air temp.	↕	Line 1	shows which temperature is measured.
Actual: 25.4 °C		Line 2	shows current temperature.
		Line 3	
	↕	Line 4	

1.d4. Exhaust air temperature.

Exhaust air temp.	↕	Line 1	shows which temperature is measured.
Actual: 21.5 °C		Line 2	shows current temperature.
		Line 3	
	↕	Line 4	

1.d5. Temperature of extract air as it leaves the building

Extract air temp.	↕	Line 1	shows which temperature is measured
Actual: 10.3 °C		Line 2	shows current temperature.
		Line 3	
	↕	Line 4	

1.d6. Freeze protection temperature.

Only shown when there is water heating.

Freeze P temp.	↕	Line 1	shows which temperature is measured.
Actual: 7.0 °C		Line 2	shows current temperature of the heating circuit's return pipe.
		Line 3	
	↕	Line 4	

Fan speed, how to change operation mode

2. Operation mode

2.1 How to set mode

Choose group of menus - see Ch. A.

> Fan control
Timer

Line 1 Choose this to change operation mode for fan.
Line 2 Choose this to set parameters for when temperatures should be lowered

2.1.1 Fan mode

Choose between the following modes:

- **Auto:** gives you an optimized function. The temperature is automatically controlled in accordance with the unit's internal and optimized algorithms.
- **Min.flow:** The system is forced to use a set minimum air flow.
- **Boost flow:** The system is forced to boost the air flow. Useful for example if you get an unpleasant smell indoors and need to air the building.
- **Max. flow:** The system works at set maximum air flow.
- **Stove:** This mode should be used when the stove/fireplace is used. The supply air fan works at a higher speed than the exhaust air fan, to compensate for the air the stove extracts.
- **Kitchen:** Use this mode when the cooker fan is running. The supply air fan works at a higher speed than the exhaust air fan, to compensate for the air the cooker fan extracts. Kitchen mode can also be started via an external switch, if it has been connected to one of the external inputs on the terminal block.
- **ECO:** Suitable to use when no one is at home. The fans switch to minimum flow, but increase to normal flow when there is need for higher temperature. The setpoint temperature is automatically lowered to the equivalent of *ECO adjust*.
- **Fire:** To be used above all when testing the fire function. The supply air fan stops at the same time as the exhaust air fan works at its maximum speed.
- **Off:** All fans are switched off..

Fan control
Mode: Auto

Line 1 name of menu.
Line 2 shows chosen mode.

2.2.1. Date and time

Adjust values if need be, also see Ch. A.

Time: 15:23
Date: 12:04:18
Weekday: Wednesday
Summer/winter time > v

Line 1 Set time
Line 2 Set date
Line 3 Set weekday
Line 4 Scroll to Summer/winter time.

2.2.1.1 Summer time

Adjust values if need be, see Ch. A.

Adjust clock auto-
 matically for
 summer time: Yes

Line 1 & 2 Headline
 Line 3 Choose YES or NO
 Line 4

2.2.2. Activate ECO mode

Adjust values if need be, see Ch. A.

Activate ECO mode
 No

Line 1 Activate ECO mode
 Line 2 Choose YES or NO
 Line 3
 Line 4

2.2.2.1. Timer - choose category

Choose group, see Ch. A.

> ECO time
 Weekend

Line 1 Enter to set ECO-timer.
 Line 2 Enter to set weekend timer.
 Line 3
 Line 4

2.2.2.1.1 ECO-timer Mondays

Adjust values if need be, see Ch. A.

Monday:
 Per 1: 08:00- 17:00
 Per 2: 00:00- 00:00

Line 1 Weekday
 Line 2 Set ECO-time period 1
 Line 3 Set ECO-time period 2
 Line 4

2.2.2.1.2 ECO-timer Tuesdays

Adjust values if need be, see Ch. A.

Tuesday:
 Per 1: 08:00- 17:00
 Per 2: 00:00- 00:00

Line 1 Weekday
 Line 2 Set ECO-time period 1
 Line 3 Set ECO-time period 2
 Line 4

2.2.2.1.3 ECO-timer Wednesdays

Adjust values if need be, see Ch. A.

Wednesday:
 Per 1: 08:00- 17:00
 Per 2: 00:00- 00:00

Line 1 Weekday
 Line 2 Set ECO-time period 1
 Line 3 Set ECO-time period 2
 Line 4

2.2.2.1.4 ECO-timer Thursdays

Adjust values if need be, see Ch. A.

Thursday:
 Per 1: 08:00- 17:00
 Per 2: 00:00- 00:00

Line 1 Weekday
 Line 2 Set ECO-time period 1
 Line 3 Set ECO-time period 2
 Line 4

2.2.2.1.5 ECO-timer Fridays

Adjust values if need be, see Ch. A.

Friday:	Line 1	Weekday
Per 1: 08:00- 17:00	Line 2	Set ECO-time period 1
Per 2: 00:00- 00:00	Line 3	Set ECO-time period 2
▼	Line 4	

2.2.2.1.6 ECO-timer Saturdays

Adjust values if need be, see Ch. A.

Saturday:	Line 1	Weekday
Per 1: 08:00- 17:00	Line 2	Set ECO-time period 1
Per 2: 00:00- 00:00	Line 3	Set ECO-time period 2
▼	Line 4	

2.2.2.1.7 ECO-timer Sundays

Adjust values if need be, see Ch. A.

Sunday:	Line 1	Weekday
Per 1: 08:00- 17:00	Line 2	Set ECO-time period 1
Per 2: 00:00- 00:00	Line 3	Set ECO-time period 2
▼	Line 4	

2.2.2.1.8 ECO-timer weekends

Adjust values if need be, see Ch. A.

Weekend:	Line 1	Weekend
Per 1: 08:00- 17:00	Line 2	Set ECO-time period 1
Per 2: 00:00- 00:00	Line 3	Set ECO-time period 2
▼	Line 4	

2.2.2.1.1.1 ECO-timer working week

Adjust values if need be, see Ch. A.

Monday->Friday:	Line 1	Weekdays in working week
Per 1: 08:00- 17:00	Line 2	Set ECO-time period 1
Per 2: 00:00- 00:00	Line 3	Set ECO-time period 2
▼	Line 4	

2.2.2.2.1 Timer weekends/holidays

Adjust values if need be, see Ch. A.

Holiday (mm:dd)	Line 1	Weekend/holiday (mm:dd)
1: 01-01 - 01-01	Line 2	Set period
2: 01-01 - 01-01	Line 3	Set period
3: 01-01 - 01-01	Line 4	Set period
▼		

2.2.2.2.2 Timer weekends/holidays - cont'd

Adjust values if need be, see Ch. A.

Holiday (mm:dd)	Line 1	Weekend/holiday (mm:dd)
4: 01-01 - 01-01	Line 2	Set period
5: 01-01 - 01-01	Line 3	Set period
6: 01-01 - 01-01	Line 4	Set period

2.2.2.2.3 Timer weekends/holidays - cont'd

Adjust values if need be, see Ch. A.

Holiday (mm:dd)	Line 1	Weekend/holiday (mm:dd)
7: 01-01 - 01-01	Line 2	Set period
8: 01-01 - 01-01	Line 3	Set period
9: 01-01 - 01-01	Line 4	Set period

2.2.2.2.4 Timer weekends/holidays - cont'd

Adjust values if need be, see Ch. A.

Holiday (mm:dd)	Line 1	Weekend/holiday (mm:dd)
10: 01-01 - 01-01	Line 2	Set period
11: 01-01 - 01-01	Line 3	Set period
12: 01-01 - 01-01	Line 4	Set period

2.2.2.2.5 Timer weekends/holidays - cont'd

Adjust values if need be, see Ch. A.

Holiday (mm:dd)	Line 1	Weekend/holiday (mm:dd)
13: 01-01 - 01-01	Line 2	Set period
14: 01-01 - 01-01	Line 3	Set period
15: 01-01 - 01-01	Line 4	Set period

2.2.2.2.6 Timer weekends/holidays - cont'd

Adjust values if need be, see Ch. A.

Holiday (mm:dd)	Line 1	Weekend/holiday (mm:dd)
16: 01-01 - 01-01	Line 2	Set period
17: 01-01 - 01-01	Line 3	Set period
18: 01-01 - 01-01	Line 4	Set period

2.2.2.2.7 Timer weekends/holidays - cont'd

Adjust values if need be, see Ch. A.

Holiday (mm:dd)	Line 1	Weekend/holiday (mm:dd)
19: 01-01 - 01-01	Line 2	Set period
20: 01-01 - 01-01	Line 3	Set period
21: 01-01 - 01-01	Line 4	Set period

2.2.2.2.8 Timer weekends/holidays - cont'd

Adjust values if need be, see Ch. A.

Holiday (mm:dd)	Line 1	Weekend/holiday (mm:dd)
16: 01-01 - 01-01	Line 2	Set period
17: 01-01 - 01-01	Line 3	Set period
18: 01-01 - 01-01	Line 4	Set period

Status inputs/outputs. Calibration of sensors.

This is where you check the status of various input and output data and the temperature sensors can be calibrated. Choose headline Inputs/outputs and scroll. To enter this group of menus, log in with access code.

3. Inputs/outputs

3.1 Inputs/outputs

Choose group, see Ch. A.

➤ Analogue inputs	Line 1	Enter to check status of analogue inputs.
Digital inputs	Line 2	Enter to check status of digital inputs.
Analogue outputs	Line 3	Enter to check status of analogue outputs.
Digital outputs	Line 4	Enter to check status of digital outputs.
Calibrate temp sens.	Line 5	Enter to calibrate temperature sensors.

3.1.1 Analogue inputs, status

Displays temperatures.

AI1 OD temp.	10.5°C	Line 1	Displays current outdoor temperature.
AI2 SA temp.	25.4°C	Line 2	Displays current supply air temperature.
AI3 EA temp.	21.5°C	Line 3	Displays current exhaust air temperature.
AI4 EXT temp.	10.3°C	Line 4	Displays current extract air temperature.

3.1.2. Analogue inputs, status - cont'd.

Displays temperatures - cont'd.

UA11 Room t	21.6°C	Line 1	Displays current room temperature.
UA12 Freeze t	12.4°C	Line 2	Displays current freeze protection temperature

3.2.1 Digital inputs, status

Displays if the input is active or not.

ON = input 24 V.

OFF = input 0 V.

DI1 Start	:On	Line 1	ON = system active. OFF= system deactivated.
DI2 Kitchen	:Off	Line 2	ON = the D12 function is activated via external switch
DI3 ECO	:Off	Line 3	ON = the D13 function is activated via external switch
DI4 SA Fan	:OK	Line 4	"Alarm" means the supply air fan is faulty.

3.2.2 Digital inputs, status - cont'd.

DI5 EA fan	:OK	Line 1	"Alarm" means the exhaust air fan is faulty.
DI6 Not active	:On	Line 2	"ON" indicates that there is a signal (DI2 function activated via ext. switch)
DI7 Overheat p.	:OK	Line 3	"Alarm" means ELECTRIC HEATING FAILURE = unit stopped
DI8 Filter alarm	:OK	Line 4	"Alarm" means filter is clogged, but the unit continues to run.

NOTE! Inputs DI2-DI3 and DI6 can be configured to various functions. This is done in the menu Configuration/System.

3.3.1. Analogue outputs, status

Displays voltage used 0-10 V.

AO1 SA fan:	5.0 V	Line 1	displays current voltage to supply air fan.
AO2 EA fan:	5.0 V	Line 2	displays current voltage to exhaust air fan.
AO3 Heating:	2.6 V	Line 3	displays current voltage to after-heater (water).
AO4 Cooling:	0.0 V	Line 4	displays current voltage to chiller (cooling coil).

3.4.1 Digital outputs, status

Displays current status of outputs.

ON = output 24 V.

OFF = output 0 V.

DO1 BP opening	: On	Line 1	ON shows that the By-pass damper is opening
DO2 BP closing	: Off	Line 2	ON shows that the By-pass damper is closing
DO3 PWM heat	: Off	Line 3	ON shows that electric heating is operating (PWM heating).
DO4 Sum alarms	: On	Line 4	ON shows that the output has been made active.

3.4.2 Digital outputs, status - cont'd.

DO5 CP heat	: Off	Line 1	ON shows that the output has been made active.
DO6 KAVK	: Off	Line 2	ON shows that the output has been made active.
DO7 ULS	: On	Line 3	ON shows that the output has been made active.

NOTE! Outputs DO4 - DO7 may be configured to either Sum alarms, CP heat, CP cool, Normal flow, Not active, KAVK (Condensation boiler) or ULS (Outdoor air damper). This is done in the menu Configuration.

3.5.1 Calibrate sensors

The temperature sensors' values may be offset. For example, the system's temperature may be synchronized with the ordinary thermometer. State the difference on this screen and the two will show the same value. To adjust the value, see Ch. A.

AI1: NaN °C K:	0.2	Line 1	Displays current offset for outdoor temperature.
AI2: NaN °C K:	0.0	Line 2	Displays current offset for supply air temperature.
AI3: NaN °C K:	-0.1	Line 3	Displays current offset for exhaust air temperature.
AI4: NaN °C K:	0.0	Line 4	Displays current offset for extract air temperature

3.5.2 Calibrate sensors - cont'd.

UAI1: NaN °C K:	0.3	Line 1	Displays current offset for room temperature.
UAI2: NaN °C K:	0.0	Line 2	Displays current offset for freeze protection temperature.
UAI3: °C K:		Line 3	Not used!
UAI4: °C K:		Line 4	Not used!

Manual control

This menu is used for manual control of controller, fans, dampers etc.

Choose the headline Manual/Auto and scroll the menus.

To enter this group of menus, log in with access code.

4. Manual/Auto

4.1. Supply air controller

Choose setting for the supply air controller - see Ch. A. Options:

- Auto: automatic and optimized.
- Manual: The controller's output can be set between 0-100 %.
- Off: the controller is turned off.

SA controller		Line 1	Shows that the parameters for the supply air controller can be adjusted.
Auto		Line 2	Displays chosen mode.
Manual output:	20.0	Line 3	Displays current output if in MANUAL mode.
		Line 4	

4.2. Supply air fan

Choose setting for the supply air fan - see Ch. A. Options:

- Auto: automatic and optimized.
- Manual: The fan's speed can be set between 0-100 %.
- Off: the fan is turned off.

Supply air fan		Line 1	Shows that the parameters for the supply air fan can be adjusted.
Manual		Line 2	Displays chosen mode.
Manual output:	20.0	Line 3	Displays current output if in MANUAL mode.
		Line 4	

4.3. Exhaust air fan

Choose setting for the exhaust air fan - see Ch. A. Options:

- Auto: automatic and optimized.
- Manual: The fan's air flow can be set between 0-100 %.
- Off: the fan is turned off.

Exhaust air fan		Line 1	Shows that the parameters for the exhaust air fan can be adjusted.
Off		Line 2	Displays chosen mode.
Manual output:	20.0	Line 3	Displays current output if in MANUAL mode.
		Line 4	

4.4 After-heater

Choose setting for the after-heater (electric/water) - see Ch. A. Options:

- Auto: automatic and optimized.
- Manual: The output to the after-heater can be set between 0-100 %.
- Off: the after-heater is turned off.

After-heater		Line 1	Shows that the parameters for the after-heater can be adjusted.
Auto		Line 2	Displays chosen mode.
Manual output:	20.0	Line 3	Displays current output if in MANUAL mode.
		Line 4	

4.5. BP / By-pass damper

Choose setting for the by-pass damper - see Ch. A. Options:

- Auto: automatic and optimized.
- Manual: damper's position can be set between 0-100 % open.
- Off: the by-pass damper is turned off.

BP / By-pass damper	↑	Line 1	Shows that the parameters for the by-pass damper can be adjusted.
Manual		Line 2	Displays chosen mode.
Manual output: 20.0		Line 3	Displays current output if in MANUAL mode.
Pos.: 100% open	↓	Line 4	Displays the BP damper's current position

4.6. Chiller (cooling coil) (The menu is shown only if "Cooling" is activated under System and "CP chiller" configured to one of the outputs)

Choose setting for the chiller - see Ch. A. Options:

- Auto: automatic and optimized.
- Manual: the chiller's effect can be set between 0-100 %.
- Closed: the chiller is turned off.

Chiller	↑	Line 1	Shows that the parameters for the chiller can be adjusted.
Auto		Line 2	Displays chosen mode.
Manual output		Line 3	Displays current output if in MANUAL mode.
	↓	Line 4	

4.7. ULS / Outdoor air damper (The menu is shown only if "ULS" is configured to one of the outputs)

Choose setting for the outdoor air damper - see Ch. A. Options:

- Auto: automatic and optimized.
- Open: damper is 100% open.
- Closed: the damper is closed.

ULS / OD air damper	↑	Line 1	Shows that the parameters for the outdoor air damper can be adjusted.
Closed		Line 2	Displays chosen mode.
		Line 3	
	↓	Line 4	

4.8. KAVK / Condensation boiler (the menu is shown only if "KAVK" is configured to one of the outputs)

Choose setting for the condensation boiler - see Ch. A. Options:

- Auto: automatic and optimized.
- On: condensation boiler turned on, i.e. water evaporates
- Off: condensation boiler is turned off.

KAVK / Cond. boiler	↑	Line 1	Shows that the parameters for the condensation boiler can be adjusted.
On		Line 2	Displays chosen mode.
		Line 3	
	↓	Line 4	

4.9. CP / Circulation pump to the after-heater (the menu is shown only if "CP heater" is configured to one of the outputs)

Choose setting for the circulation pump to the after-heating - see Ch. A. Options:

- Auto: automatic and optimized.
- On: the pump is operating.
- Off: the pump is turned off.

CP / Circ. pump After-heater: On	↑	Line 1	Shows that the parameters for the circulation pump can be adjusted.
		Line 2	Displays chosen mode.
		Line 3	
	↓	Line 4	

4.10. CP / Circulation pump chiller (the menu is shown only if "Cooling" is activated under System and "CP chiller" configured to one of the outputs)

Choose setting for the chiller's circulation pump to the - see Ch. A. Options:

- Auto: automatic and optimized.
- On: the pump is operating.
- Off: the pump is turned off.

CP / Circ. pump Cooling: Auto	↑	Line 1	Shows that the parameters for the circulation pump can be adjusted.
		Line 2	Displays chosen mode.
		Line 3	
	↓	Line 4	

4.11. Fire damper (the menu is shown only if "Fire" is activated under System and "Fire damper" configured to one of the outputs)

Choose setting for the fire damper - see Ch. A. Options:

- Auto: automatic and optimized.
- On: the dampers are open.
- Off: the dampers are closed.

Fire damper Auto	↑	Line 1	Shows that the parameters for the circulation pump can be adjusted.
		Line 2	Displays chosen mode.
		Line 3	
	↓	Line 4	

4.12. Filter timer

Set and clear filter timer

Filter timer Interval: 12 m Remains: 11 m Set zero: No	↑	Line 1	Name of menu.
		Line 2	Adjustable 6-19 months.
		Line 3	Shows remaining months until next filter exchange
	↓	Line 4	Clear timer, yes or no.

Alarms

5. Alarm history

The last 21 alarms are displayed. You can see when the alarm went off, when it was acknowledged and/or returned to normal, etc. This screen can only be monitored.

Current alarms and their status are displayed if you press the red button  This is where you deal with alarms: acknowledge, block or open them.

The alarms are classified according to the severity of the fault.

Some alarms lead to an immediate shut-down of the unit.

Even if an alarm has been returned (dealt with), it must also be acknowledged in order to remove it from the list of current alarms.

An acknowledged alarm that has not yet been dealt with remains on the screen as *Acknowledged*. It disappears from the screen when the fault has been dealt with.

Menu screen, example (Current alarms).

Failure EA fan	↑	Line 1	Shows type of alarm
		Line 2	
19 Mar 09:49 Class: A	↓	Line 3	Shows when it occurred and how it is classified.
		Line 4	Shows alarm status, if any.

Press OK - options are shown.

Options:

Acknowledge

Block or unblock

Cancel

Failure EA fan	↑	Line 1	Shows type of alarm.
		Line 2	
> Acknowledge	↓	Line 3	Options how to deal with alarm (scroll up or down)
Block		Line 4	Choose action.

Menu screen, example (Alarm history).

19 Mar 09:59 A	↑	Line 1	Shows when it occurred and how it is classified
Failure EA fan		Line 2	Shows type of alarm.
		Line 3	
Blocked	↓	Line 4	Shows alarm status.

List of alarms (abbreviations – see page 43)

Sensor error OD temp	El.heat. overheated	P1-heating manual
Sensor error SA temp	Filter guard	P1-cooling manual
Sensor error EA temp	Chiller manual	SA fan manual
Sensor error EXT temp	Heater manual	EA fan manual
Sensor error RM temp	By-pass manual	SA controller man.
Sensor error FRP temp	ULS (Outdoor air damper)	Int. battery failure
Freeze P alarm	manual	Filter alarm
Supply fan failure	KAVK (Condensation	Fire damper alarm
Exhaust fan failure	boiler) manual	Fire alarm

Configuration

6. Configuration - categories - options

This menu is used for the configuration of the complete AHU.

Choose group of menus - see Ch. A..

To enter this group of menus, log in with access code.

> Control function	↑
Control temp.	
PID output	
Fan speeds	↓

Line 1 Set control functions.
Line 2 Set parameters for control.
Line 3 PID - controller output.
Line 4 Set fan speeds.

Heating coil

Line 5 Type of additional heating.

By-pass

Line 6 Parameters for By-pass, Defrost etc.

Cold air recovery

Line 7 Parameters for recovery of night chill.

Night cooling

Line 8 Times and parameters for recovery of night chill.

KAVK

Line 9 Parameters for KAVK / Condensation boiler.

I/O configuration

Line 10 Configuration of digital inputs and outputs.

System

Line 11 System setting, made at the factory.

6.1 Control functions

6.1.1 Control functions - options

Choose control functions - see Ch. A. Options:

- Supply air control: the temperature is controlled by the supply air sensor alone.
- Outdoor temperature compensated supply air control: The temperature is controlled as a function of the supply air with compensation for outdoor air temperature.
- Cascaded room control: Cascade control of room temperature and supply air temperature to achieve a constant, settable room temperature. The room controller output signal generates the supply air controller's setpoint value.
- Cascaded exhaust air control: Cascade control of exhaust air temperature and supply air temperature to achieve a constant, settable room temperature. The exhaust air controller output signal generates the supply air controller's setpoint value.

Control function
Cascaded room.

Line 1 Name of menu.
Line 2 Shows chosen control function.

6.1.1.1 Cascaded room temperature control (min/max supply air setpoint)

Min. and max. parameters can be adjusted - see Ch. A.

When cascade control
Max/min SA setp.
Max: 52.0 °C
Min: 17.0 °C

Line 1 shows menu.
Line 2 shows which parameters can be adjusted.
Line 3 displays set max. value
Line 4 displays set min. value.

6.2 Control of temperatures

6.a2.1. Control of temperatures

The control parameters can be adjusted if need be. Factory settings for proportional and integral constants are 100 and 300, which is OK in most cases.

WARNING! Incorrect setting leads to poorly functioning system!

Room controller
P-band: 100.0 °C
I-time: 300.0 sec

Line 1 shows controller concerned.
 Line 2 displays set proportional constants, P value
 Line 3 displays set integral constants, I value

P-Value is often expressed as the temperature change needed for the actuator to move from closed to fully open position. A (too) small P-value gives a less stable system. A small change of the actual temperature gives full heat and therefore a large overshoot of the temperature. A small P-value gives a smoother transition to the setpoint, but may give a long time until setpoint is reached. An I-value can help minimizing overshoots and increases the possibility to reach the setpoint.

6.b2.1. Control of temperatures

See also 6.a2.1.

EA controller
P-band: 100.0 °C
I-time: 300.0 sec

Line 1 shows controller concerned.
 Line 2 displays set proportional constants, P value
 Line 3 displays set integral constants, I value

6.c2.1. Control of temperatures

See also 6.a2.1.

SA controller
P-band: 100.0 °C
I-time: 300.0 sec

Line 1 shows controller concerned.
 Line 2 displays set proportional constants, P value
 Line 3 displays set integral constants, I value

6.3 PID output

6.3.1. PID output

Displays the output of the different controllers.

PID output ↑
Heating : 100 %
By-pass : 100 %
Cooling : 0 % ↓

Line 1 Name of menu.
 Line 2 displays the output of the heating controller
 Line 3 displays opening of the by-pass damper.
 Line 4 displays output of the cooling controller

6.4 Fan speed

6.4.1. Fan speed

Choose fan - see Ch. A

> SA fan
 EA fan
 Temp. difference

Line 1 Supply air fan, speed
 Line 2 Exhaust air fan, speed
 Line 3 Temperature difference to reach maximum fan speed in ECO mode.

6.4.1.1 Fan speed, supply air fan, part 1

Adjust settings if need be - see Ch. A.

Min = 20 % ↑
 Normal = 50 %
 Boost = 80 %
 Kitchen = 80 % ↓

Line 1 Fan speed when minimum air flow
 Line 2 Fan speed when normal air flow
 Line 2 Fan speed when boosted air flow
 Line 2 Fan speed when Kitchen mode

6.4.1.2. Fan speed, supply air fan, part 2

Adjust settings if need be - see Ch. A.

Stove = 80 %
 Night cool = 30 %
 Max. = 100%
 Fire = 0 % ↓

Line 1 Fan speed when Stove mode
 Line 2 Fan speed when Night cooling mode
 Line 3 Fan speed when maximum air flow
 Line 4 Fan speed in case of fire.

6.4.1.3. Fan speed delay, supply air fan

Adjust settings if need be - see Ch. A.

Delay SA fan ↑
 Start: 0 sec
 Stop: 60 sec
 Rise time (V/s) : 1

Line 1 Name of menu
 Line 2 Delay of supply air fan at start-up
 Line 3 Supply air fan delay time after stop
 Line 4 Rise of speed (V/sec) during start and stop. Concerns output 0-10 V.

6.4.2.1. Fan speed exhaust air fan, part 1

Adjust settings if need be - see Ch. A.

Min. = 20 % ↑
 Normal = 50 %
 Boost = 80 %
 Kitchen = 20 % ↓

Line 1 Fan speed when minimum air flow
 Line 2 Fan speed when normal air flow
 Line 2 Fan speed when boosted air flow
 Line 2 Fan speed when Kitchen mode

6.4.2.2. Fan speed exhaust air fan, part 2

Adjust settings if need be - see Ch. A.

Stove = 80 %
 Night cool = 30 %
 Max. = 100%
 Fire = 100 % ↓

Line 1 Fan speed when Stove mode
 Line 2 Fan speed when Night cooling mode
 Line 3 Fan speed when maximum air flow
 Line 4 Fan speed in case of fire.

6.4.2.3. Fan speed delay, exhaust air fan

Adjust settings if need be - see Ch. A.

Delay EA fan ↑
 Start: 0 sec
 Stop: 60 sec
 Rise time (V/s) : 1

Line 1 Name of menu
 Line 2 Delay of exhaust air fan at start-up
 Line 3 Exhaust air fan delay time after stop
 Line 4 Rise of speed (V/sec) during start and stop. Concerns output 0-10 V.

6.4.3.1. Difference in temperature (only shown when ECO is configured)

Adjust settings if need be - see Ch. A.

Temp. diff. to reach ↑
 fan speed in ECO
 mode: 35.0 °C
 Hysteresis : 0.2

Line 1 & 2 Headline (Temperature difference to reach maximum fan speed in ECO mode.)
 Line 3 Set temperature
 Line 4 Hysteresis

6.5 After-heater

6.5.1. After-heater

Choose type of after-heater - see Ch. A. Options:

- Water.
- Electric.

Type of heater
 Water

Line 1 Headline
 Line 2 Heat source chosen

6.5.1.1 Period

Only applicable if Electric after-heater has been chosen above. Set period.

Period: 60 sec

Line 1 Set time period

6.6 By-pass

6.6.1. Exchanger defrosting

Adjust settings if need be - see Ch. A.

Defrost temp. 5.0 °C
Time before defrost starts: 3 h
Defrost time: 5 min

Line 1 shows outdoor temperature when defrosting should start.
Line 2 + 3 shows continuous time with temperature lower than that chosen before defrosting starts
Line 4 shows time for defrosting

6.6.2. Time to reach open/closed by-pass damper

Adjust settings if need be - see Ch. A.

BP valve's running time interval: 45 s
Current position 0 % open

Line 1 & 2 shows the time the By-pass damper takes to reach open mode from closed (and reverse)
Line 3 & 4 displays the damper's estimated current position.

6.7 Recovery of cold air

6.7.1. Recovery of cold air

Adjust settings if need be - see Ch. A.

Recover cold air: No
Recover if OD temp. + 2.0 °C is higher than EXT temp.

Line 1 Recovery of cold air: YES or NO.
Line 2 Conditions for recovery
Line 3 Choose temperature
Line 4 Conditions for recovery

6.8 Night cooling

6.8.1. Night cooling, settings, start

Adjust settings if need be - see Ch. A.

Activ. night cool: No
Activate if OD temp higher than 22 °C

Line 1 Headline
Line 2 Choose Yes or No
Line 3 Conditions for activating Night cooling
Line 4 Choose temperature

6.8.2. Night cooling, settings, stop

Adjust settings if need be - see Ch. A.

Stop if night OD temp. above: 15.0 °C
under: 5.0 °C
RM temp. under 18.0 °C

Line 1 Headline
Line 2 Conditions for deactivating Night cooling
Line 3 Conditions for deactivating Night cooling
Line 4 Conditions for deactivating Night cooling

6.9 KAVK / Condensation boiler

6.9.1. KAVK, settings, start, stop

Adjust settings if need be - see Ch. A.

KAVK / Cond. boiler
Start temp: 5.0 °C
Stop temp: 7.0 °C

Line 1 Headline
 Line 2 Choose temperature when KAVK should start (OD temp)
 Line 3 Choose temperature when KAVK should stop (OD temp)

(6.10 Fire function - not applicable to RT250/400 units)

6.11 I/O configuration

6.11.1. Choice of I/O categories

Choose category - see Ch. A.

> **Digital inputs**
Digital outputs

Line 1 Category
 Line 2 Category
 Line 3
 Line 4

6.11.1.1 Configuration digital inputs

Choose function for each input.

Options for DI2, DI3 and DI6:

- Not active, Minimum air flow, Boosted air flow, Kitchen mode, ECO mode, Stove mode or Fire.

Options for DI4:

- SA (Supply air) fan EC or SA converter

Options for DI5:

- EA (Exhaust air) fan EC or EA converter

DI2= Not active
DI3= Not active
DI4= SA fan EC
DI5= EA fan EC

Line 1 Function DI2
 Line 2 Function DI3
 Line 3 Function DI4
 Line 4 Function DI5

6.11.1.2 Configuration digital inputs - cont'd.

DI6= Not active

Line 1 Function D16.

6.11.2.1 Configuration digital outputs

Choose function for each output.

Options for D04, D05, D06 and D07:

- Not active, KAVK / Condensation boiler, ULS / Outdoor air damper, Sum alarms, CP heating, Normal flow

DO4= Sum alarms
DO5= CP heat
DO6= KAVK
DO7= OD air damper

- Line 1 Function DO4
- Line 2 Function DO5
- Line 3 Function DO6
- Line 4 Function DO7

6.12 Modbus (only shown when Modbus is configured)

6.12.1 Set Modbus parameters

Choose address.

Choose baud rate:

- 150, 300, 600, 1200, 2400, 4800, 9600 or 19200

Choose Parity

- None, Odd or Even

Modbus address: 1	Line 1 Modbus address.
Baud rate: 9600 bps	Line 2 Baud rate
Parity: Even	Line 4 Parity

6.13 System

6.13.1 Optional extras - activate

Choose category - see Ch. A.

> Activate functions	Line 1 Category.
Filter timer	Line 2 Category.
Communication	Line 3 Category.

6.13.1.1 Activate optional extra functions

Activ. Cooling: No	Line 1 Activate function - Yes or No
Activ. Kitchen: No	Line 2 Activate function - Yes or No
Activ. Stove: No	Line 3 Activate function - Yes or No
Activ. Fire: No	Line 4 Activate function - Yes or No

6.13.1.2 Activate optional extra functions - cont'd.

Activ. ECO: No	Line 1 Activate function - Yes or No
Activ. ECO2: No	Line 2 Activate function - Yes or No

6.13.2.1 Activate filter timer

Activ. Filter timer	Line 1 Headline
No	Line 2 Choose Yes or No

6.13.3.1 Configuration of communication parameters

Choose category - see Ch. A.

> Modbus EXOline address	Rad 1 Parameters for Modbus. Rad 2 The AHU's address. Rad 3 Rad 4
-----------------------------	--

6.13.3.1.1 Activate Modbus' communication

Modbus communication Modbus: Not activated	Rad 1 Headline. Rad 2 Modbus Not aktivated or Activated.
---	---

6.13.3.1.2 Modbus parameters

Choose address.

Choose baud rate:

- 150, 300, 600, 1200, 2400, 4800, 9600 or 19200

Choose Parity

- None, Odd or Even

Modbus address: 1 Baud rate: 9600 bps Parity: Even	Line 1 Modbus address. Line 2 Baud rate Line 4 Parity
--	---

6.13.3.2 The AHU's address

Address PLA: 254 ELA: 30	Line 1 Headline. Line 2 PLA address Line 3 ELA address Line 4
--------------------------------	--

Authorization and access codes

7. Authorization

7.1. Authorization

This is where you log in with your code to be able to change various parameters, such as temperature setpoint.

There are three different authorizations:

- User Access code: 3333. Adjustments suitable for the user to make, such as temperature, operation mode etc.
- Technician Access code: 2222. Intended for trained professionals with good knowledge of the AHU. **WARNING! Wrong settings may jeopardize the AHU's functions and performance.**
- REC Intended for configurations made by the factory.

> Log in	Line 1	Log in
	Line 2	
	Line 3	
	Line 4	

Alt. menu screen: Authorization

NOTE! This menu is only available if you have logged in.

Log in	Line 1	Log in with code to enter authorized level
> Log out	Line 2	Log out.
Change code	Line 3	Change code for any of the authorizations.
	Line 4	

7.1.1 Log in

State code - see Ch. A

If the correct code is stated, you will gain access to the authorized level.

If the Current level says "None", you cannot make any adjustments, but you may study the information.

Log in	Line 1	Menu Log in
State code: ****	Line 2	State access code.
Current level: None	Line 3	Tells you with which authorization you have logged in.
	Line 4	

7.2.1 *Log out*

NOTE! This menu is only available if you have logged in.

Change "No" to "Yes" - see Ch. A.

Having logged out, you will automatically return to the Control unit main screen

Want to log out?

No

Level: Technician

Line 1

Line 2 Choose: Yes or No

Line 3 Displays the authorization level you have entered..

Line 4

7.3.1 *Change access code*

NOTE! This menu is only available if you have logged in.

Choose authorization level for which the new code applies.

Options:

- User
- Technician
- REC

Change code for

Level: Technician

New code: ****

Line 1

Line 2 Shows authorization level for which the new code applies.

Line 3 Enter new access code.

Line 4

Cleaning

For best possible performance and a long life, the AHU should be kept clean. Please see instructions below on how to clean fans and heat exchanger.

Changing filters

There are two filters in this AHU: exhaust air filter and supply air filter (fresh air). Both filters should be changed at least once a year, and often if need be. Do not wash the filters, but exchange them for new ones.

To buy new filters, please contact the local dealer in your country or order from www.rec-indovent.se

 **NOTE!** The Temovex AHU must be fitted with the Temovex filters listed on page 1 of this manual. If the unit operates without filters, the performance will be affected adversely and fans and heat exchanger may be seriously damaged.



(Ref. numbers - see page 6)

- Cut off the power using the main switch.
- Open the unit door (1).
- Remove Cover plate A (see page 2).
- Take hold of the filter (2) or of the clamp between the bags. Push the front part backwards, downwards.
- The supply air filter (7) is behind the inner over plate, behind the exhaust filter. Remove the filter.
- Clean accessible surfaces if necessary.
- Fit the new filters in reverse order (the blue, exhaust air filter, is fitted in the front).
- Refit the access door.
- Close the unit door.
- Turn on the power.

The unit operates even if the filters are dirty, but the performance would be less good; energy consumption increases and heat recovery decreases.

To turn off/acknowledge filter alarm, see Ch 5.

Cleaning the fans

- Cut off the power using the main switch.
- Open the unit door (1).
- Remove both covers (4 and 5)
- Clean one fan at a time.
- Undo the fan's electric plug and pull out the fan.
- Clean the impeller using a brush or compressed air.
- Refit the fans in reverse order.
- Refit the covers.



- Close the unit door.
- Switch on the power using the main switch.

 **NOTE!** The fans must under no circumstances be cleaned under running water!

Cleaning the heat exchanger

- Cut off the power using the main switch.
- Open the unit door (1).
- Remove both covers (4 and 5) and remove both fans (see above).
- Open the inspection door (8)
- Remove the red plug at the bottom of the unit, the condensate drain (10)
- Flush the heat exchanger with hot water.



NOTE! If the unit is fitted with a condensate evaporator unit (KAVK), a wet vac should be used to deal with the rinse water.

A degreasing agent may be required if the heat exchanger is very dirty.

 **NOTE!** The agent must be of a type which is not aggressive to aluminium. Alkaline detergents with caustic ammonia and alike must never be used, since they have a corrosive action on aluminium, i.e. ruin the heat exchanger.

- Refit the red plug (10) (On the same side of the unit as the filters).
- Refit the inspection door (8).
- Refit the fans in reverse order (4, 5)

 **NOTE!** Make sure the fan motors are not/don't get wet when restarting the unit. If wet, this could be fatal!

- Refit the covers.
- Close the unit door.
- Switch on the power using the main switch.

Checking the condensate drain

- Open the unit door (1).
- Open the access door (8) at the bottom of the cabinet.
- Make sure the drain is not blocked. This can be done by pouring some water into the bottom of the unit.



NOTE! On the side which does not have a red plug.

- If the drain is jammed, try to remove the obstruction. If need be, call a plumber.
- Refit the access door.
- Close the unit door.

Cleaning the air diffusers

The building's air diffusers must be cleaned regularly in order to maintain correct ventilation. Use a dry cloth and/or a small brush to reach inside the opening of the diffuser. It can also be taken down if that makes cleaning easier. Use a duster or a dry cloth to remove possible dirt marks in the ceiling around the device.



NOTE! The air diffuser's setting must not be changed. If taken down, each diffuser must be returned to its original place.

Cleaning the duct system

The exhaust air ducts - and sometimes the supply air ducts as well - may need cleaning at long intervals. Dust and dirt will deteriorate the capacity of the AHU if not removed.

Authorized ventilation cleaners should carry out the cleaning. However, you yourself can easily clean the part of the duct which is close to the air diffusers.

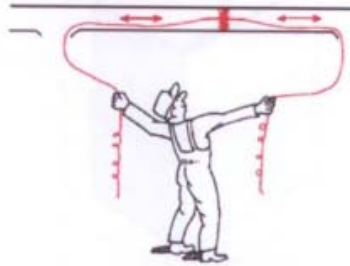





Take down the diffuser. Use a vacuum cleaner or duster to clean the inner part of the duct as far as you can reach. Refit the diffuser, making sure the setting is not changed.

Checking the outdoor air intake

Once a year the outdoor air intake should be checked. Make sure it is not clogged by for example leaves, snow or ice.

Service

Service and repairs, beyond normal maintenance, should be carried out by professionals in the ventilation field, or - if electricity is involved - by an authorized electrician.

-  The electric panel must not be opened by other than authorized specialist.
-  The plates covering the fans must not be removed when the AHU is running, as there is a risk of contact with moving parts. Make sure the electricity has been cut off (unplugged or fuse removed).
-  Interference with the AHU system may affect the warranty terms.
-  Use original spare parts only.

Disposal

Prevent accidents when the AHU is disposed of. Remove the cable from the wall socket and cut it as close to the unit as possible. Store and transport the waste unit lying down. Please leave the unit to be recycled where such facilities exist. Check with your local authority for recycling advice..

List of abbreviations

Act.	actual
AHU	air handling unit
BP	by-pass damper
Casc.	cascaded
Comp.	compensate(d)
CP	circulation pump
DUC	controller
EA	exhaust air
El.heat.	electric heating
EXT	extract air
FRP	freeze protection
h	hour
Int.	Internal
I-time	integration time
I/O	input/output
KAVK	condensation boiler
mm:dd	month:day

OD	outdoor
P	protection
per.	period
pos.	position
PWM	electric heating
RM	room
s	second
Setp.	setpoint
SA	supply air
Temp.	temperature
ULS	outdoor air damper

DATE is shown in the format YY-MM-DD.

TIME is shown in 24-hour format.

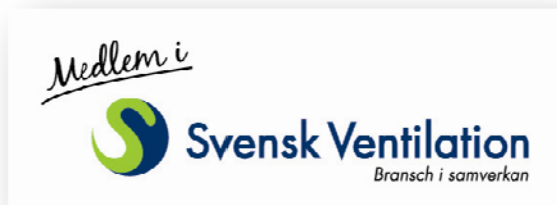

REC Indovent AB reserves the right to make alterations to specification and construction without prior notification.



REC Indovent AB

P.O. box 37, SE-431 21 Mölndal, Sweden
Street address: Kärragatan 2

Tel: +46 31 67 55 00
Fax: +46 31 87 58 45

www.rec-indovent.se

Certified acc. to ISO 9001/14001