

SAVE VTC 300 Heat Recovery Ventilation Unit

User Manual

GB

Document in original language | 211465 · A001



© Copyright Systemair UAB
All rights reserved
E&OE

Systemair UAB reserves the rights to change their products without notice.
This also applies to products already ordered, as long as it does not affect the previously agreed specifications.

Contents

1	Disposal and recycling	1
2	Warnings.....	1
3	Type label.....	1
3.1	QR code	2
4	Introduction	2
5	SAVECair control	3
5.1	General.....	3
5.2	Startup wizard	3
5.3	Common symbols.....	3
5.4	Menu overview	4
5.5	Home screen.....	5
5.5.1	User modes	5
5.5.2	Temperature settings	7
5.5.3	Airflow settings	7
5.5.4	Indoor Air Quality	8
5.5.5	Status line	8
5.6	Description of User function icons	8
5.7	Week Schedule.....	9
5.7.1	Schedule airflow settings	9
5.7.2	Edit schedule	9
6	Maintenance.....	10
6.1	Warnings.....	10
6.2	Changing Outdoor/Extract air filters.....	11
6.2.1	Resetting the filter time	11
6.3	Checking the heat exchanger	12
6.4	Cleaning the fans	12
6.5	Removing the Inspection door.....	13
7	Duct system maintenance	14
7.1	Cleaning extract louvres and supply air diffusers.....	14
7.2	Checking the outdoor air intake	14
7.3	Checking the roof cowl (if fitted).....	14
7.4	Checking and cleaning the duct system	14
8	Troubleshooting.....	14
9	Alarms.....	16
9.1	Alarm list.....	16

1 Disposal and recycling

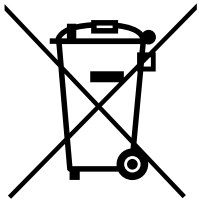

This product is compliant to the WEEE directive. When disposing the unit, follow your local rules and regulations.
This product packing materials are recyclable and can be reused. Do not dispose in household waste.



2 Warnings



Danger

- Make sure that the mains supply to the unit is disconnected before performing any maintenance or electrical work!
- All electrical connections and maintenance work must be carried out by an authorized installer and in accordance with local rules and regulations.



Warning

- This product must only be operated by a person who has suitable knowledge or training within this field or carried out with the supervision of a suitably qualified person.
- Beware of sharp edges during mounting and maintenance. Use protective gloves.



Warning

- All though the mains supply to the unit has been disconnected there is still risk for injury due to rotating parts that have not come to a complete standstill.

Important

- The installation of the unit and complete ventilation system must be performed by an authorized installer and in accordance with local rules and regulations.
- The system should operate continuously, and only be stopped for maintenance/service.
- Do not connect tumble dryers to the ventilation system.
- Duct connections/duct ends must be covered during storage and installation.
- Make sure that filters are mounted before starting the unit.

3 Type label

Before calling your service representative, make a note of the specification and production number from the type label, which can be found on the side of the units, next to the external connections.

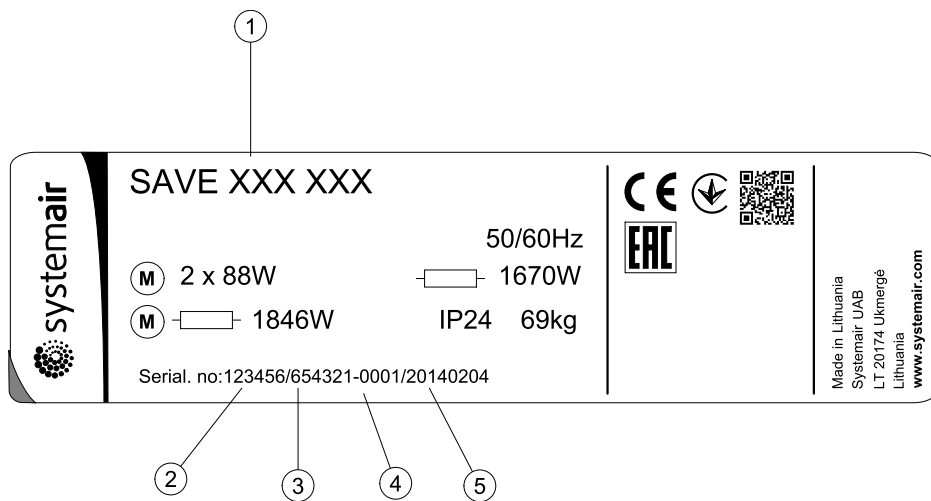

Fig. 1 Type label

Position	Description
1	Product code (product specification)
2	Product item number
3	Production order number
4	Serial number
5	Production date (YY.MM.DD)

3.1 QR code

QR code is an optical label that contains the list of spare parts and documentation. The QR code label can be found next to the type label.

Use a mobile application or any other QR code reader to access its contents.

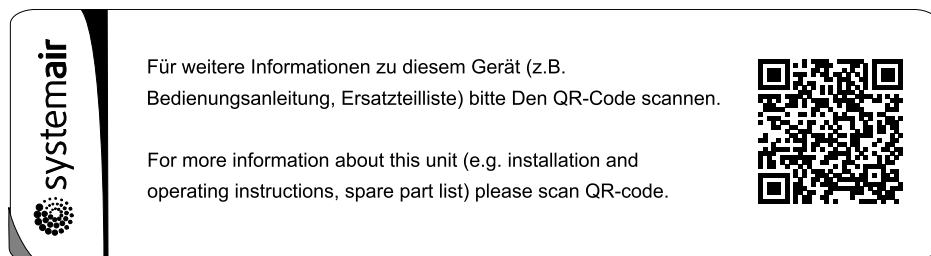

Fig. 2 Example of QR code label

4 Introduction

The SAVE VTC 300 is a heat recovery ventilation unit with a built in counter flow plate heat exchanger. There are two model options, right (R) and left (L) model (figure 3). The different models are recognized by the control panel which is situated on the right side of the unit in an (R) unit and on the left side in an (L) unit.

This manual describes basic information how to operate and perform maintenance on the unit and the system it is connected to.

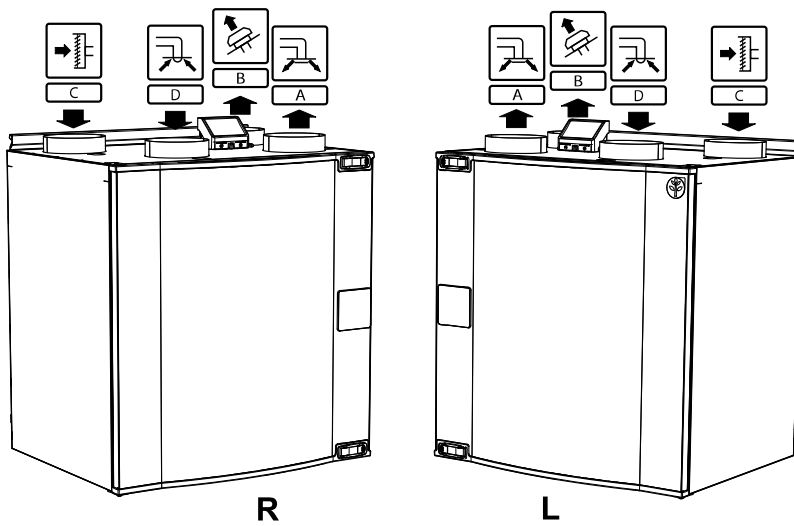





Fig. 3 Right and Left models

Table 1 Symbol description

Symbol		Description
	A	Supply air
	B	Exhaust air
	C	Outdoor air
	D	Extract air

5 SAVECair control

5.1 General

SAVECair is a modern touchscreen LCD control panel, simply known as HMI – Human Machine Interface. The touchscreen display provides information about current state of the unit and allows you to control all system functions.

Settings are done by touching the icons or options. The touch screen is sensitive and it is not necessary to press too hard.

5.2 Startup wizard

During the first power up of the unit, you will be asked to set:

- menu language
- time and date
- airflow control type (Manual/RPM) and airflow level values
- heater type (None/Electrical/Water/Change-over)

If the start-up wizard is cancelled it will start again during next power up of the unit, this will continue until start-up wizard is successfully finished.

5.3 Common symbols

The following selection symbols are common and are present in most menu pages:



Back button to return to a previous menu, located at the upper left corner



Up arrow to increase a value



Down arrow to decrease a value



On and Off slider to activate or deactivate a function. White bubble – function is inactive, green bubble – function is active.

CANCEL

Button to cancel changes

SET/OK

Buttons to confirm changes

Many options show up in a form of the pop-up window. Select the option from the displayed list in the pop-up window and press OK to confirm selection.

5.4 Menu overview

- A. Return to home screen
- B. Basic read-only information about the unit
- C. Currently active alarms and alarm history
- D. Configure and check week schedule
- E. Check and change remaining time till filter change
- F. General system preferences
- G. Configuration of all system parameters
- H. Help and troubleshooting menu

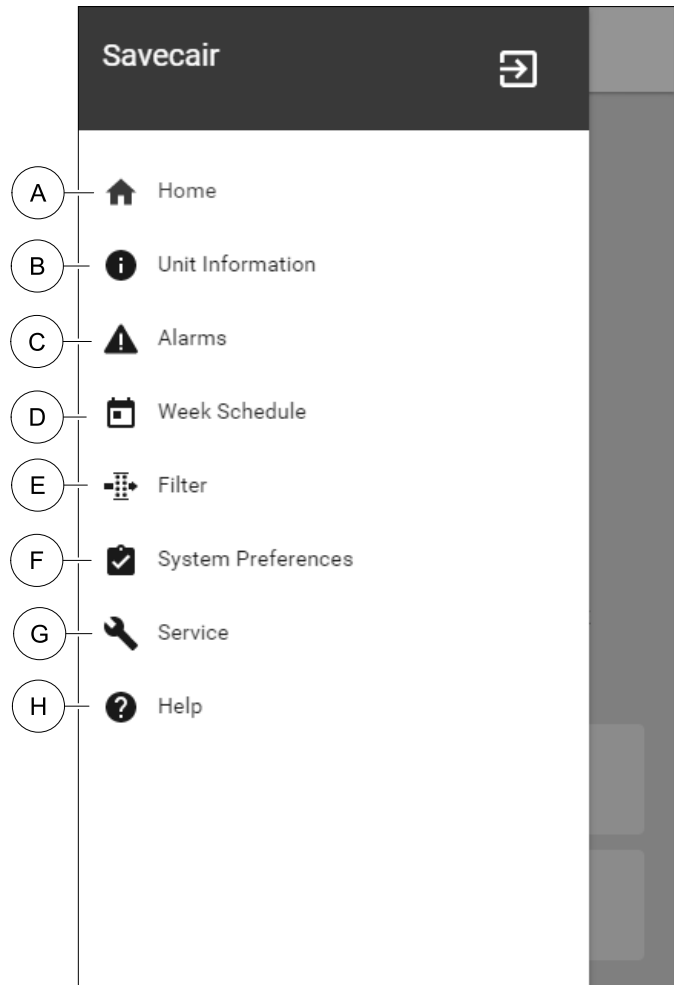

5.5 Home screen

 Touching home icon (pos. A) in drop-down menu list (pos. 1) will always returns you to home screen after commissioning.

1. Drop-down menu list
2. Active user mode
3. Airflow settings
4. Temperature settings
5. List of active alarms
6. Icon list of active user functions

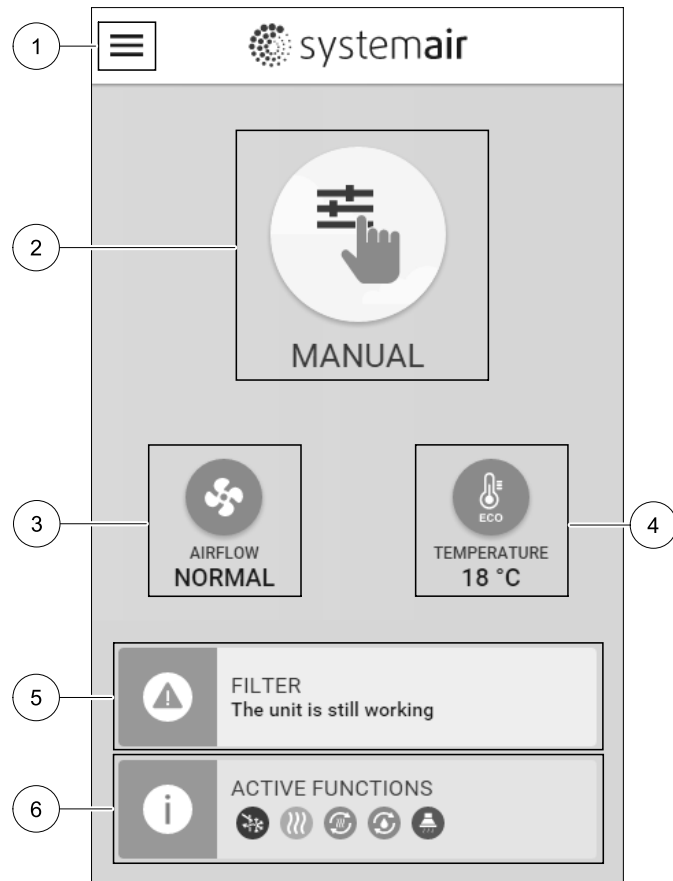



5.5.1 User modes

The first icon at the top of home screen shows currently active user mode. To change the user mode, touch the active user mode icon (pos. 2) and select a new user mode from the list. The unit has 2 permanent and 5 temporary user modes available for selection. Only one mode can be active at a time.

Settings of all modes can be modified in *Service* menu.

5.5.1.1 Permanent modes





Permanent modes are always active unless interrupted by temporary modes, activated user functions or alarms:

Icon	Text	Description
	AUTO	Automatic airflow control. <i>AUTO</i> mode is available for selection when <i>Demand Control</i> , <i>Week Schedule</i> and/or external fan control functions are configured, otherwise <i>AUTO</i> mode icon won't be visible in active user modes menu. <i>AUTO</i> mode activates <i>Demand Control</i> , <i>Week Schedule</i> and/or external fan control functions. <i>Demand</i> is available to choose as airflow setting in <i>Week Schedule</i> .
	MANUAL	Manual selection of airflow levels. The unit can be set run at one out of four available airflow speeds: <i>Off</i> / <i>Low</i> / <i>Normal</i> / <i>High</i> .

Note: The fan can be set to *OFF* by activating *Manual Fan Stop* function in *Service* menu.

5.5.1.2 Temporary modes

Temporary modes are active only for a set period of time unless interrupted by active user modes, activated user functions or alarms:



Icon	Text	Description
	HOLIDAY	Sets speed of both supply and extract air fans to Low levels when user is away from home for a long period of time. ECO mode is active. Delay in days.
	CROWDED	Sets speed of both supply and extract air fans to maximum High levels and temperature setpoint offset to -3 K when apartment is more crowded than usual. Default temperature setpoint offset is -3 K. Delay in hours.
	AWAY	Sets speed of both supply and extract air fans to Low levels when user is away from home for a short period of time. ECO mode is active. Delay in hours.
	REFRESH	Sets speed of both supply and extract air fans to maximum High levels to replace indoor air with a fresh air in a short period of time. Delay in minutes.
	FIREPLACE	Sets speed of supply air fan to High level and extract air fan to Low level to increase air pressure within the apartment for better smoke extraction through the chimney. Delay in minutes.

Settings of all modes can be modified in *Service* menu.

Temporary modes and user functions are active only for a set period of time after which they are terminated and the unit changes back to a former **AUTO** or **MANUAL** mode, depending on which one was active before temporary mode or user function was activated.

5.5.1.3 Digital input functions

Digital input functions always active while digital input is activated.

Icon	Text	Description
	Central Vacuum Cleaner	Function sets speed of supply air fan to High level and extract air fan to Low level to increase air pressure within the apartment for better dust collection through central vacuum cleaner. Function can be activated via digital input – Central Vacuum Cleaner Function .
	Cooker Hood	Sets speed of supply air fan to High level and extract air fan to Low level to increase air pressure within the apartment for better airborne grease and steam collection in the kitchen. Function can be activated via digital input – Cooker Hood Function .

5.5.1.4 Digital input and Mode hierarchy

User modes and functions have a different hierarchy. User functions activated via HMI or mobile APP, such as **AWAY**, **CROWDED**, **FIREPLACE**, **HOLIDAY** and **REFRESH**, are interrupted by manual selection of **AUTO** and **MANUAL** fan modes.

A **FIREPLACE** function has the highest priority between user functions. Other functions activated via HMI/APP can interrupt each other.

If **FIREPLACE** function is hard-wired on the connection board and configured as digital input (DI) then it has a higher priority than **AUTO** and **MANUAL** mode. Digital input for a **FIREPLACE** function has also a higher priority than other hard-wired digital inputs (DI) for: **AWAY**, **CENTRAL VACUUM CLEANER**, **COOKER HOOD**, **CROWDED**, **HOLIDAY** or **REFRESH**.

Digital input and Mode hierarchy:

1. **EXTERNAL STOP**
2. **FIREPLACE** function
3. **COOKER HOOD**, **CENTRAL VACUUM CLEANER**, **CROWDED**, **REFRESH** functions
4. **AWAY**, **CROWDED** functions

5.5.2 Temperature settings



Temperature can be set at **SET TEMPERATURE** menu accessible from the home screen by touching **TEMPERATURE** icon with thermometer. Default temperature value is 18°C (range 12–30°C).

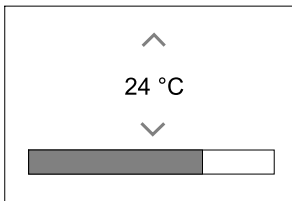

Use up and down arrows or a slider to change the value.

Then touch the **SET** to confirm changes.

Temperature set point is for room air temperature, supply air temperature or for extract air temperature depending on which control mode is active. Default setting is **Supply air temperature control**.

Control mode of the temperature can be changed in **Service** menu.

5.5.2.1 ECO mode



ECO mode is a power saving function that can be activated in **SET TEMPERATURE** menu.

While **ECO mode** is active, a temperature setpoint at which heater is activated is lowered to avoid activation of the heater during cold nighttime.

If the temperature is very low and the heater is activated during the nighttime (even with lowered temperature setpoint), then during the upcoming daytime indoor temperature will be increased using the heat exchanger so that accumulated heat could be used during the next cold nighttime, the lowered setpoint for the heater remains.

ECO mode will have impact for the following user functions/modes if selected:	ECO mode is always activated by the following modes:
<ul style="list-style-type: none"> • AUTO mode • MANUAL mode • AWAY mode • HOLIDAY mode • CENTRAL VACUUM CLEANER function • COOKER HOOD function • FIREPLACE mode 	<ul style="list-style-type: none"> • AWAY mode • HOLIDAY mode <p>ECO mode is always deactivated by the following user functions/modes:</p> <ul style="list-style-type: none"> • CROWDED mode • REFRESH mode • FREE COOLING function

5.5.3 Airflow settings

Airflow settings are available only in **MANUAL** mode. Click on fan icon on the main screen to enter **SET AIRFLOW** menu.

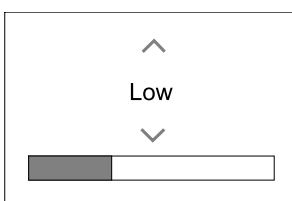

Use up and down arrows or a slider to change the airflow value.

The airflow may be adjusted in these steps: **Off/Low/Normal/High**. These settings control output signals to the supply and extract fans.

Important

It is **not** recommended to set fan to *off* in standard households. If manual fan stop is activated, the unit should be provided with dampers in exhaust and fresh air ducts to avoid cold draught and risk of condensation when the unit has been stopped.
The fan can be set to *off* by activating *Manual Fan Stop* function in *Service* menu.

5.5.4 Indoor Air Quality

The unit automatically controls indoor humidity and/or CO₂ levels by adjusting airflow setting. Airflow is increased if air quality is decreasing.

Demand Control function is responsible for IAQ (Indoor Air Quality) regulation. Relative humidity (RH) and/or CO₂ sensors are responsible for IAQ monitoring.

Indoor air quality (IAQ) indicator is available if *AUTO* mode and *Demand Control* function is activated.

IAQ levels:

- *ECONOMIC*: Actual IAQ value is below low IAQ set point.
- *GOOD*: Actual IAQ value is between low and high IAQ limits.
- *IMPROVING*: Actual IAQ value is above high IAQ set point.

Different airflow settings can be set for *IMPROVING* and *GOOD* IAQ levels in *Service* menu.

Setpoint for relative humidity and CO₂ level can be set in *Service* menu.

5.5.5 Status line

Status line located at the bottom area of home screen displays information about:



List of active alarms. See chapter 9.1 for more information.







List of active user functions. See chapter 5.6 for more information.

Touching any of these lines will move you to the next page with more detailed list and information about each alarm or active user function.

5.6 Description of User function icons

Icon	Text	Description
	Heating	Connected heater or pre-heater is active and air heating is in process.
	Heat recovery	Heat recovery from apartment is active.
	Cooling	Connected cooler is active and air cooling is in process.
	Cooling recovery	Automatic cooling recovery is active when extract air temperature from apartment is lower than outdoor air temperature and there is a cooling demand (temperature setpoint is lower than outdoor air temperature). No cooling recovery with heating demand. If the outdoor air temperature is higher than the indoor air temperature and there is a heating demand, function <i>Free heating</i> is activated instead.
	Free cooling	Function decreases indoor air temperature by using only cool outdoor air during nighttime to save energy consumption.
	Moisture transfer	Function controls the rotation speed of the heat exchanger to prevent moisture transfer to supply air due to high relative humidity in the extract air. Function is only available for units with <i>Rotating</i> type heat exchanger.

Icon	Text	Description
	Defrosting	Function prevents formation of the ice on the heat exchanger during cold outdoor temperatures.
	Secondary air	Warm air from the living space is used to defrost the heat exchanger using a damper inside the outdoor air duct. The unit switches from outdoor air to secondary air while the extract air fan stops and warm secondary air increases the temperature inside the heat exchanger.
	Vacuum cleaner	Function sets speed of supply air fan to High level and extract air fan to Low level to increase air pressure within the apartment for better dust collection through central vacuum cleaner. Function can be activated via digital input – Central Vacuum Cleaner Function. Always active while digital input is activated.
	Cooker hood	Sets speed of supply air fan to High level and extract air fan to Low level to increase air pressure within the apartment for better airborne grease and steam collection in the kitchen. If a cooker hood with integrated fan is used, then it is recommended to set airflow levels of both fans to Normal. Function can be activated via digital input – Cooker Hood Function. Always active while digital input is activated.
	User lock	Function indicates that the system is locked with a password and cannot be edited or settings changed in any way. System must be unlocked first to make changes.

5.7 Week Schedule



The unit can be configured to operate at set airflow levels up to two time periods (00:00–23:59) on user selected days.
Week Schedule is active only during AUTO mode.

5.7.1 Schedule airflow settings

Touch settings icon to go to SCHEDULE AIRFLOW SETTINGS menu. In this menu set airflow level for scheduled and unscheduled periods. Available levels: Off, Low, Normal, High or Demand.
Set temperature setpoint offset for both periods (-10°C – 0°C).



Demand level is available only if Demand Control or External fan function is active.

5.7.2 Edit schedule



Touch icon at the bottom left corner of the screen to add a new schedule or press EDIT button to modify already added schedule.

To configure the schedule:

1. Set the time. Touch the START TIME or END TIME values to change time. Use arrow buttons  and  to increase or decrease value. Confirm with OK button.



Note:

Scheduled time can start but never end at midnight (00:00). The latest END TIME period is 23:59.
Scheduled time cannot go to the next day.

If necessary, activate second scheduled period and set up time.

2. Once time is set, click on the day(s) when schedule should be active. It is possible to set a separate schedule for each day.

Already scheduled days are not available for selection for new schedules.

3. Confirm schedule with OK button.

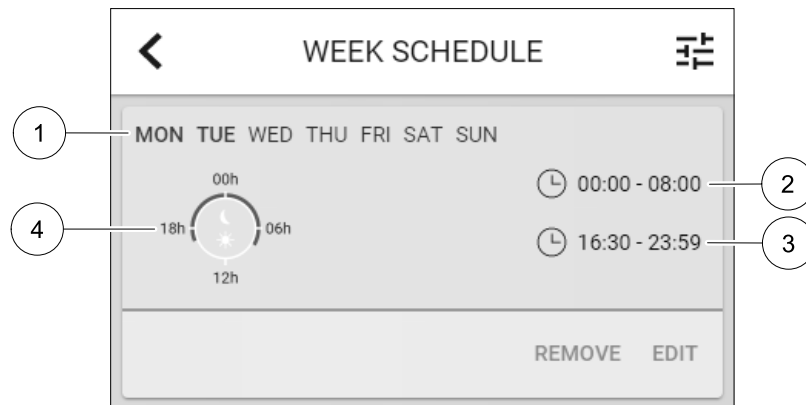

Fig. 4 Week schedule example

Scheduled days are highlighted (pos. 1). First time period (pos. 2) and the second time period (pos. 3) are shown on the right side of each schedule.

Scheduled time period is displayed in blue colour on the clock (pos. 4).

6 Maintenance

Maintenance of the SAVE VTC 300 should normally be performed 3 - 4 times a year. Apart from general cleaning the following should be observed:

6.1 Warnings



Danger

- Make sure that the mains supply to the unit is disconnected before performing any maintenance or electrical work!
- All electrical connections and maintenance work must be carried out by an authorized installer and in accordance with local rules and regulations.



Warning

- This product must only be operated by a person who has suitable knowledge or training within this field or carried out with the supervision of a suitably qualified person.
- Beware of sharp edges during mounting and maintenance. Use protective gloves.



Warning

- All though the mains supply to the unit has been disconnected there is still risk for injury due to rotating parts that have not come to a complete standstill.

6.2 Changing Outdoor/Extract air filters

The filters cannot be cleaned and must be changed as necessary. This is normally done 1–2 times per year depending on the air pollution at the installation site.

When it's time to change the filters an alarm is shown in the control panel display. When this occurs do the following:

1. Change filters as shown in below illustration (figure 5).
2. Reset the filter time as described below (chapter 6.2.1). Depending on the condition of the filter, you might need to change the operation time for the filter.

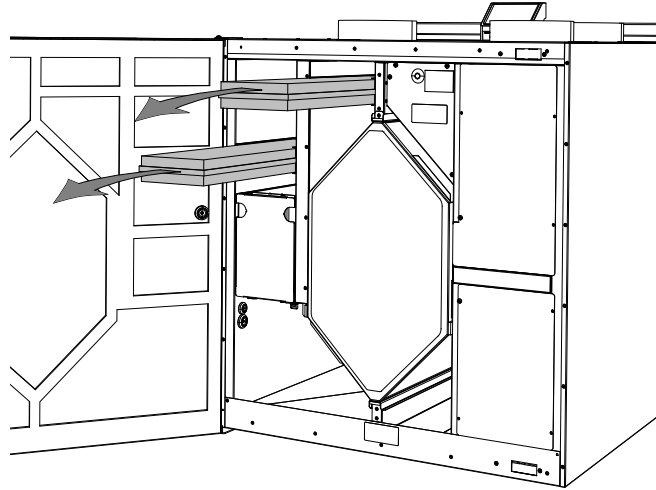

Fig. 5 Changing of filters

6.2.1 Resetting the filter time

Once filter is changed, it is necessary to reset filter time. Go to **Filter** menu (see 5.4 *Menu overview*, page 4, pos. E) or if filter alarm is present, click on alarm status line (see 5.5 *Home screen*, page 5, pos. 5) and select filter alarm. Select **CHANGE FILTER**, in the pop up menu define a new filter period and press **OK** to confirm selection.

Filter time is now reset.

6.3 Checking the heat exchanger

Even if the required maintenance is carried out (chapter 6.2), dust will build up in the exchanger block. It is therefore of vital importance for the upkeep of a high efficiency that the exchanger block is removed from the unit and cleaned periodically as illustrated below (figure 6). Cleaning the heat exchanger can be done every 3 years.

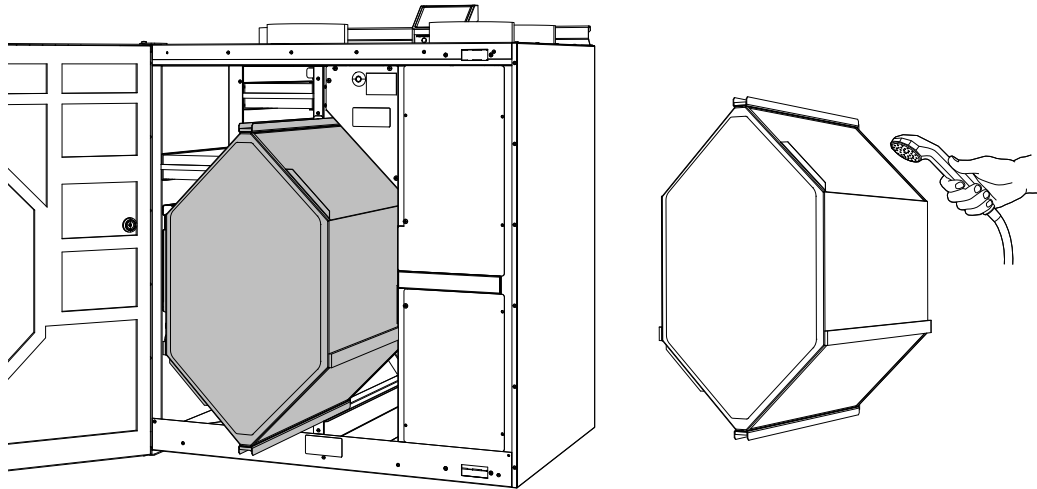

Fig. 6 Removing and cleaning the heat exchanger

6.4 Cleaning the fans

Even if the required maintenance, such as changing of filters is carried out, dust and grease may slowly build up inside the fans. This will reduce the efficiency.

The fans may be cleaned as illustrated in below procedure.

- 1 Disconnect the unit from the mains by pulling out the wall plug

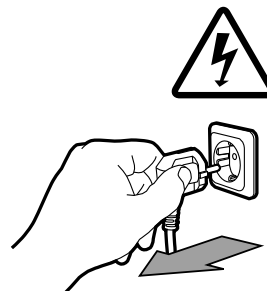

- 2 Remove the cover plates

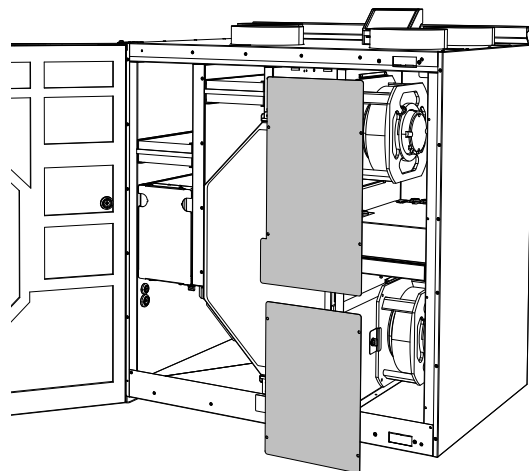

- 3 Disconnect the fast couplings

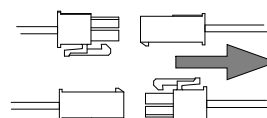

- 4 Loosen the bracket holding the fan and pull the fan out carefully

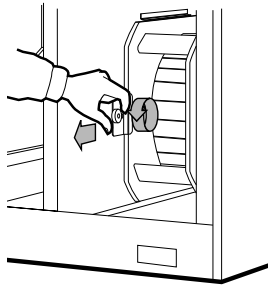

- 5 Clean the fan using a cloth or a soft brush. Do not use water. White spirit can be used to remove obstinate settlements. Allow to dry properly before remounting.

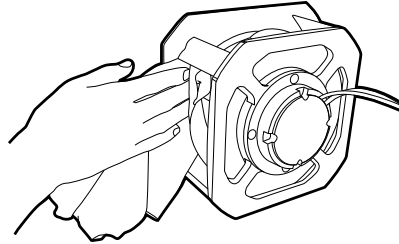

6.5 Removing the Inspection door

In case the unit is installed in a tight space it might be necessary to remove the inspection door to perform cleaning and maintenance. Remove the door according to below procedure.

- 1 Disconnect the unit from the mains by pulling out the wall plug.

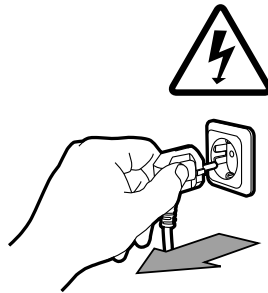

- 2 Remove the cover plate of the bypass damper motor.

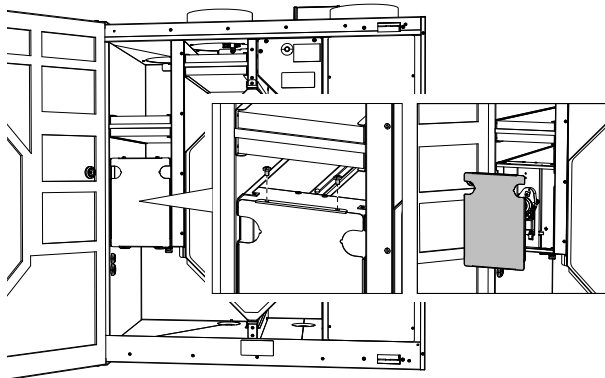

- 3 Disconnect the modular plug from the modular jack situated behind the bypass damper cover plate.

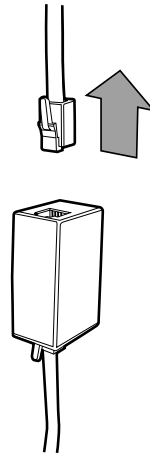

- 4 Unscrew the door from the hinges.

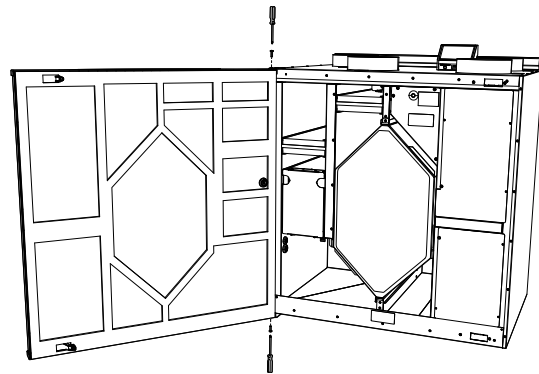

7 Duct system maintenance

7.1 Cleaning extract louvres and supply air diffusers

The system supplies fresh air to your home and extracts the used indoor air via the duct system and diffusers/louvres. Diffusers and louvres are mounted in ceilings/walls in bedrooms, living room, wet rooms, WC etc. Remove diffusers and louvres and wash in hot soapy water as required (diffusers/louvres must not be exchanged). Cleaning of diffusers/louvres can be done as necessary.

7.2 Checking the outdoor air intake

Leaves and pollution could plug up the air intake grille and reduce the capacity. Check the air intake grille, and clean as necessary. It is recommended to do this at least twice a year.

7.3 Checking the roof cowl (if fitted)

The roof cowl (if fitted) connected to the exhaust air duct needs to be checked at least twice a year and cleaned if necessary.

7.4 Checking and cleaning the duct system

Dust and grease deposits may build up in the duct system, even if required maintenance such as changing of filters is being carried out. This will reduce the efficiency of the installation.

The duct runs should therefore be cleaned/changed when necessary. Steel ducts can be cleaned by pulling a brush soaked in hot soapy water through the duct via diffuser/louvre openings or special inspection hatches in the duct system (if fitted).

It is recommended to do this every 5 years and is normally carried out by authorized companies specialized in this area.

8 Troubleshooting

If problems should occur, please check the items below before calling your service representative.

Malfunction	Action
Fans do not start	<ol style="list-style-type: none"> 1. Check the HMI for alarms. 2. Check that all fuses and fast couplings are connected (main power supply and fast couplings for supply and extract air fans). 3. Check that the week schedule is ON and running in AUTO mode. The week schedule might be in OFF mode with the air flow set to OFF (chapter 5.7).
Reduced airflow	<ol style="list-style-type: none"> 1. Check the HMI for alarms. Some alarms can reduce the airflow to LOW if active. 2. The unit could be in defrost mode. This reduces the fan speed and in some cases shuts down the supply air fan completely during the defrosting cycle. The fans go back to normal after finished defrosting. There should be a defrosting function icon visible in the APP or HMI home screen if defrosting is active. 3. If the outdoor air temperature is below 0°C (Outdoor air temperature sensor (OAT) measures < 0°C) outdoor airflow compensation function can be active (if enabled). Fan speed (Supply or Supply/Extract air fans) is linearly reduced for decreasing outdoor air temperature. 4. Check if temporary user mode that reduces airflow is not activated, for example AWAY, HOLIDAY, etc. Also check digital inputs CENTRAL VACUUM CLEANER and COOKER HOOD. 5. Check setting of airflow in the HMI. 6. Check week schedule settings (chapter 5.7). 7. Check filters. Is change of filters required? 8. Check diffusers/louvres. Is cleaning of diffusers/louvres required? 9. Check fans and heat exchange block. Is cleaning required? 10. Check if the buildings air intake and roof unit (exhaust) have been clogged. 11. Check visible duct runs for damage and/or build up of dust/pollution. 12. Check diffuser/louvre openings.
The unit cannot be controlled (control functions are stuck)	<ol style="list-style-type: none"> 1. Reset control functions by pulling out the plug for 10 seconds. 2. Check the modular contact connection between the HMI and the main printed circuit board.
Low supply air temperature	<ol style="list-style-type: none"> 1. Check the display for alarms. 2. Check the active user functions in HMI screen if Defrosting function is running. 3. Check set supply air temperature in the HMI. 4. Check if ECO mode is activated in HMI (it is a power saving function and prevents the heater from activating). 5. Check if user modes HOLIDAY, AWAY or CROWDED are activated in the HMI or via a hardwired switch. 6. Check the analogue inputs in the service menu to verify that the temperature sensors are functioning correctly. 7. In case of installed electrical/other re-heater battery: Check if the overheat protection thermostat is still active. If necessary, reset by pressing the red button on the front plate of the electrical re-heater. 8. Check if the extract filter must be changed. 9. Check if the unit has a re-heater battery connected. At very cold outdoor conditions an electrical or water heating battery might be necessary. A re-heater battery can be acquired as an accessory.
Noise/vibrations	<ol style="list-style-type: none"> 1. Clean fan impellers. 2. Check that the screws holding the fans are tightened. 3. Check that the anti vibration lists are fitted to the mounting bracket and to the back of the unit. 4. Check that the rotor belt is not slipping if the unit has rotating heat exchanger.

9 Alarms

No Alarms message is displayed if there are no active or logged alarms.

Press **HELP** button on the active alarm to access FAQ and troubleshooting (if available). Press **ACKNOWLEDGE** on the individual alarm to clear it. Depending on alarm type and the cause, it might be necessary to do a troubleshooting first to acknowledge active alarm.

It may be not possible to clear the status of alarm if the cause of alarm is still present, as that would immediately trigger alarm to return.

9.1 Alarm list

Alarm name	Explanation	Do the following
Frost protection	Frost protection of return water in heating coil. <ul style="list-style-type: none"> Alarm stops the unit and opens the water valve completely. 	The alarm will reset once the water temperature reaches 13°C. Check the water fluid temperature in heating coil. Check the circulation pump of water heater. Contact your installation company or place of purchase.
Frost protection temperature sensor	Indicates malfunction of water heater temperature sensor. <ul style="list-style-type: none"> Alarm stops the unit. 	Check that frost protection temperature sensor is connected properly and cable is not damaged. Contact your installation company or place of purchase.
Defrosting error	Indicates failure of pre-heater to preheat the incoming outdoor air (in case Extra controller is configured as Preheater). <ul style="list-style-type: none"> Alarm stops the unit. 	Check the pre-heater reset button. Check the pre-heater cabling. Contact your installation company or place of purchase. Defrosting error may be caused by extremely low outdoor air temperatures or pre-heater failure.
Supply air fan rpm	Rotation speed of the supply air fan is lower than minimum required. Fan malfunction. <ul style="list-style-type: none"> Alarm stops the unit. 	Check quick connectors of the fan. Contact your installation company or place of purchase.
Extract air fan rpm	Rotation speed of the extract air fan is lower than minimum required. Fan malfunction. <ul style="list-style-type: none"> Alarm stops the unit. 	Check quick connectors of the fan. Contact your installation company or place of purchase.
Supply air fan control error	Flow or pressure alarm for supply air. The pressure is bellow pressure limit. <ul style="list-style-type: none"> Alarm stops the unit. 	Check that air tube for pressure sensor is connected properly and cable is not damaged. Contact your installation company or place of purchase.
Extract air fan control error	Flow or pressure alarm for extract air. The pressure is bellow pressure limit. <ul style="list-style-type: none"> Alarm stops the unit. 	Check that air tube for pressure sensor is connected properly and cable is not damaged. Contact your installation company or place of purchase.
Fire alarm	Fire alarm is active. <ul style="list-style-type: none"> Alarm stops the unit. 	Once the external Fire alarm is disabled – alarm has to be acknowledged and unit restarted.

Alarm name	Explanation	Do the following
Emergency thermostat	Indicates triggered overheat protection (in case of installed electric re-heater battery).	A triggered manual or automatic overheat protection (EMT) gives an alarm in the control panel. In case a manual overheat protection is triggered, reset it by pushing the reset button. If the automatic overheat protection is triggered, it will reset automatically once the temperature has dropped. If the problem continues contact your installation company or place of purchase.
Bypass damper	Indicates malfunction in bypass damper.	Disconnect the main power supply for 10 seconds to reset control function. Power up the unit, an automatic bypass damper test will be performed. If the alarm occurs again after approximately 2 minutes – contact your installation company or place of purchase.
Rotor guard	Indicates a rotor malfunction. No rotation guard signal for 180 seconds.	If the rotating heat exchanger has stopped. Check the rotor belt. If the heat exchanger is still rotating, check that the quick connector for the sensor is connected and that there is an air gap of 5-10 mm between the sensor and the magnet. Adjust the gap if necessary. If the alarm persists, the rotor sensor may be faulty. Contact your installation company or place of purchase.
Secondary air damper	Secondary air defrosting failed. Outdoor air temperature sensor measures < 10°C in 2 sec after defrosting OR Outdoor air temperature sensor measures < 5°C in 5 min after defrosting	Check if secondary air damper is in correct position. Check that damper is connected properly and cable is not damaged. Contact your installation company or place of purchase.
Outdoor air temperature sensor	Indicates outdoor air temperature sensor malfunction.	Check that sensor is connected properly and cable is not damaged. Contact your installation company or place of purchase.
Overheat temperature sensor	Indicates overheat temperature sensor malfunction.	Check that sensor is connected properly and cable is not damaged. Contact your installation company or place of purchase.
Supply air temperature sensor	Indicates supply air temperature sensor malfunction.	Check that sensor is connected properly and cable is not damaged. Contact your installation company or place of purchase.
Room air temperature sensor	Indicates room air temperature sensor malfunction.	Check that sensor is connected properly and cable is not damaged. Contact your installation company or place of purchase.

Alarm name	Explanation	Do the following
Extract air temperature sensor	Indicates extract air temperature sensor malfunction.	Check that sensor is connected properly and cable is not damaged. Contact your installation company or place of purchase.
Extra controller temperature sensor	Indicates extra controller temperature sensor malfunction.	Check that sensor is connected properly and cable is not damaged. Contact your installation company or place of purchase.
Efficiency temperature sensor	Indicates efficiency temperature sensor malfunction.	Check that sensor is connected properly and cable is not damaged. Contact your installation company or place of purchase.
PDM RH	Indicates internal relative humidity sensor malfunction. Active: measured humidity = 0% Returned: measured humidity > 5%	Check that sensor is connected properly and cable is not damaged. Contact your installation company or place of purchase.
PDM RH Extract air temperature	Indicates internal extract air temperature sensor malfunction. Active: measured temperature = 0°C Returned: measured temperature > 5°C	Check that sensor is connected properly and cable is not damaged. Contact your installation company or place of purchase.
Filter	Time for filter change.	Change the filter. Change filter according to the instructions in the User Manual. Details about filter retailers can be found in Help menu.
Extra controller alarm	Error from external device.	Check if external device is connected properly and cable is not damaged. Reset overheat protection on electrical pre-heater. Contact your installation company or place of purchase.
External stop	Unit is stopped by external signal.	Operation is stopped by digital signal from external remote device or signal from building management system.
Manual fan stop active	Operation stopped, fans are in manual mode and selected as OFF.	Select another speed of fans (LOW / NORMAL / HIGH) or AUTO mode in HMI home screen.
Overheat temperature	Temperature after reheater is too high. Active: (Overheat temperature sensor measures > 55°C) Returned: (Overheat temperature sensor measures < 50°C)	Alarm is possible if supply airflow is too low when the reheater is switched on. Check the supply airflow. Check that intake grille is not blocked. Check that shut off damper for outdoor air is open in operation. Contact your installation company or place of purchase.
Low supply air temperature	Supply air temperature is too low. Active: (Outdoor air temperature sensor measures < 0°C) AND (Supply air temperature sensor measures < 5°C) Returned: (Supply air temperature sensor measures > 10°C)	Check the heat exchanger and re-heater or refer to Point 2 in "Troubleshooting" menu.

Alarm name	Explanation	Do the following
CO ₂	External CO ₂ sensor malfunction.	Check that sensor is connected properly and cable is not damaged. In case sensor wireless – check RS485 gateway status and sensor status in HMI. Contact your installation company or place of purchase.
RH	External relative humidity sensor malfunction.	Check that sensor is connected properly and cable is not damaged. In case sensor wireless – check RS485 gateway status and sensor status in HMI. Contact your installation company or place of purchase.
Output in manual mode	One or more of analogue outputs are in manual mode.	Check Service menu for Output settings, and check all configured outputs to be in Auto mode. If any outputs in Manual - change back to Auto mode.



Systemair UAB
Ling st. 101
LT-20174 Ukmergė, LITHUANIA

Phone +370 340 60165
Fax +370 340 60166

www.systemair.com